

**ADCS-601-AF™**  
**Air Data Calibration Standard**  
**Operation and Maintenance Manual**  
**NSN 6695-01-534-6087**



*Pressurized gases are potentially hazardous. Energy stored in these gases can be released unexpectedly and with extreme force. Pressurized systems should be assembled and operated only by personnel who have been instructed in proper safety practices.*

---

© 2005 - 2007 **DH Instruments, a Fluke Company** All rights reserved.

Information in this document is subject to change without notice. No part of this document may be reproduced or transmitted in any form or by any means, electronic or mechanical, for any purpose, without the express written permission of **DH Instruments, a Fluke Company** 4765 East Beautiful Lane Phoenix Arizona 85044-5318 USA.

**DH Instruments** makes sincere efforts to ensure the accuracy and quality of its published materials; however, no warranty, expressed or implied, is provided. **DH Instruments** disclaims any responsibility or liability for any direct or indirect damages resulting from the use of the information in this manual or products described in it. Mention of any product or brand does not constitute an endorsement by **DH Instruments** of that product or brand. This manual was originally composed in English and was subsequently translated into other languages. The fidelity of the translation cannot be guaranteed. In case of conflict between the English version and other language versions, the English version predominates.

**DH Instruments, DH, DHI, ADCS-601-AF, ADCS Tools, AMH, COMPASS, FPG8601, PG7601, PPC3 and RPM4** and are trademarks, registered and otherwise, of **DH Instruments, a Fluke Company**.

**Swagelok** and **Nupro** are registered trademarks of the Swagelok Company.  
**Krytox** is a registered trademark of the Dupont de Nemours Company.  
**Windows, Excel, Word** are registered trademarks of the Microsoft Corporation.

Products described in this manual are manufactured under international patents and one or more of the following U.S. patents: 6,701,791, 5,142,483, 5,257,640, 5,331,838, 5,445,035. Other U.S. and international patents pending.

Document No. 550140d  
051222  
Printed in the USA



# TABLE OF CONTENTS

**TABLE OF CONTENTS** ..... I

**TABLES** ..... V

**FIGURES** ..... VI

**ABOUT THIS MANUAL** ..... IX

**1. INTRODUCTION** ..... 1

**1.1 SPECIFICATIONS**..... 1

**1.1.1 ADCS SYSTEM GENERAL SPECIFICATIONS** ..... 1

**1.1.2 PG7601 PISTON GAUGE SPECIFICATIONS** ..... 2

            1.1.2.1 AMBIENT AND PISTON-CYLINDER CONDITION MEASUREMENTS ..... 2

            1.1.2.2 PISTON-CYLINDER MODULE ..... 2

            1.1.2.3 MASS SET ..... 3

**1.1.3 FPG8601 GENERAL SPECIFICATIONS**..... 3

            1.1.3.1 AMBIENT AND PISTON-CYLINDER CONDITION MEASUREMENTS ..... 3

**1.1.4 PRESSURE MEASUREMENT AND CONTROL SPECIFICATIONS** ..... 3

            1.1.4.1 10 TO 380 KPA, PG7601 AND PPC3-700K ..... 3

            1.1.4.2 1 TO 15 KPA, FPG8601 AND PPC3-100K ..... 4

**2. SYSTEM OVERVIEW** ..... 5

**2.1 ADCS-601-AF SYSTEM**..... 5

        2.1.1 REFERENCE BENCH..... 12

        2.1.2 CONTROL CABINET ..... 13

        2.1.3 GAS SUPPLY PANEL ..... 15

**2.2 PRESSURE STANDARDS**..... 16

**2.2.1 PG7601 PISTON GAUGE**..... 16

            2.2.1.1 PG7601 PLATFORM..... 17

            2.2.1.2 PG7601 TERMINAL ..... 17

            2.2.1.3 PG7601 10 KPA/KG PISTON-CYLINDER MODULE ..... 18

            2.2.1.4 AMH-38 AUTOMATED MASS HANDLER ..... 19

            2.2.1.5 AMH-38 MASS SET ..... 21

**2.2.2 FPG8601 FORCE BALANCED PISTON GAUGE** ..... 21

            2.2.2.1 FPG8601 PLATFORM ..... 23

**2.2.3 PPC3 PRESSURE CONTROLLERS** ..... 23

        2.2.4 RPM4 A116K REFERENCE PRESSURE MONITOR..... 25

**2.3 VACUUM PUMPS** ..... 27

**3. INSTALLATION** ..... 29

**3.1 UNPACKING AND INSPECTION**..... 29

        3.1.1 ADCS CONTROL CABINET ..... 30

        3.1.2 ADCS REFERENCE BENCH AND ACCESSORIES..... 30

        3.1.3 PG7601 PLATFORM AND BELL JAR ..... 32

        3.1.4 PG7601 PISTON-CYLINDER MODULE (PC-7100/7600-10,TC) ..... 32

        3.1.5 PG7601 MASS SET (MS-AMH-38)..... 33

        3.1.6 PG7601 AUTOMATED MASS HANDLER (AMH-38) ..... 34

        3.1.7 FPG8601 PLATFORM, PISTON-CYLINDER AND ACCESSORIES..... 34

        3.1.8 FPG8601 MASS SET (MS-8601-2)..... 35

        3.1.9 SCROLL VACUUM PUMPS ..... 35

        3.1.10 TURBO MOLECULAR VACUUM PUMP ..... 35

            3.1.11 SYSTEM CONTROLLER ..... 35

            3.1.12 SYSTEM CONTROLLER STAND..... 36

<b>3.2</b>	<b>SITE REQUIREMENTS</b> .....	<b>36</b>
<b>3.3</b>	<b>SETUP</b> .....	<b>38</b>
3.3.1	POSITION THE REFERENCE BENCH .....	38
3.3.2	INSTALL REFERENCE TURBO VACUUM AND ROUGHING PUMPS.....	39
3.3.3	POSITION THE PG7601 AND FPG8601 PLATFORMS ON THE REFERENCE BENCH .....	40
3.3.4	PREPARE FPG8601 .....	40
3.3.5	MAKE PNEUMATIC INTERCONNECTIONS ON THE REFERENCE BENCH.....	41
3.3.6	POSITION CONTROL CABINET AND MAKE PNEUMATIC, COMMUNICATIONS AND ELECTRICAL CONNECTIONS TO REFERENCE BENCH .....	42
3.3.7	CONNECT PRESSURE SUPPLIES TO CONTROL CABINET.....	43
3.3.8	APPLY SUPPLY PRESSURES AND CHECK GAS SUPPLY PANEL SETTINGS .....	43
3.3.9	SET UP THE PG7601 .....	44
3.3.9.1	PREPARE THE PLATFORM AND INSTALL THE PISTON-CYLINDER MODULE .....	44
3.3.9.2	INSTALL THE AMH-38 MASS SET .....	44
3.3.9.3	INSTALL THE AMH-38 MASS HANDLER .....	45
3.3.9.4	INSTALL THE REFERENCE VACUUM CDG ASSEMBLY .....	46
3.3.10	COMPLETE FPG8601 SETUP .....	47
3.3.10.1	INSTALL THE PISTON-CYLINDER.....	47
3.3.10.2	CONNECT THE MANIFOLD AND VALVE 9.....	47
3.3.10.3	INSTALL THE REFERENCE VACUUM CDG ASSEMBLY .....	48
3.3.11	COMPLETE REFERENCE VACUUM INTERCONNECTIONS .....	49
3.3.12	INSTALL THE UTILITY VACUUM PUMP.....	49
3.3.13	SET UP THE SYSTEM CONTROLLER (PC).....	49
<b>3.4</b>	<b>POWER UP, INITIALIZATION, VERIFICATION</b> .....	<b>50</b>
3.4.1	MAIN POWER SWITCHES .....	50
3.4.2	SET OR VERIFY DEVICE COMMUNICATION PORT AND OTHER SETTINGS .....	50
3.4.2.1	COMMUNICATION PORTS.....	50
3.4.2.2	PG7601 EXTERNAL VACUUM GAUGE COMMUNICATION .....	50
3.4.2.3	EDIT AND SELECT PG7601 SETUP FILE.....	51
3.4.3	PG7601 .....	51
3.4.3.1	POWER UP.....	51
3.4.3.2	INITIALIZATION .....	51
3.4.4	FPG8601 .....	52
3.4.4.1	POWER UP.....	52
3.4.5	START UP SYSTEM CONTROLLER AND SOFTWARE.....	52
3.4.6	VERIFY SYSTEM OPERATION .....	53
<b>3.5</b>	<b>ENTER VALUE OF LOCAL GRAVITY</b> .....	<b>54</b>
<b>3.6</b>	<b>SPECIFY TEST GAS SPECIES</b> .....	<b>55</b>
<b>3.7</b>	<b>ADDITIONAL PRECAUTIONS TO TAKE BEFORE MAKING PRESSURE MEASUREMENTS</b> .....	<b>55</b>
<b>3.8</b>	<b>SHUT DOWN AND RESTART</b> .....	<b>55</b>
3.8.1	RESTART.....	55
3.8.2	SHUT DOWN .....	56
3.8.2.1	SHORT TERM SHUT DOWN .....	56
3.8.2.2	LONG TERM SHUT DOWN.....	56
<b>4.</b>	<b>OPERATION</b> .....	<b>57</b>
<b>4.1</b>	<b>GENERAL OPERATING PRINCIPLES</b> .....	<b>57</b>
4.1.1	SYSTEM CONFIGURATION.....	57
4.1.2	READY/NOT READY INDICATIONS.....	57
4.1.2.1	OVERVIEW .....	57
4.1.2.2	READY/NOT READY WHEN USING THE PG7601 PISTON GAUGE .....	57
4.1.2.3	READY/NOT READY WHEN USING THE FPG8601 FORCE BALANCED PISTON GAUGE.....	58
4.1.3	TRANSITION BETWEEN STANDARDS, ACTIVE AND INACTIVE STANDARD.....	58
4.1.4	DIFFERENCE BETWEEN REQUESTED AND ACTUAL SET PRESSURE .....	59
4.1.5	ASOLUTE AND GAUGE MEASUREMENT MODES .....	60
<b>4.2</b>	<b>FREQUENTLY USED FUNCTIONS</b> .....	<b>60</b>
4.2.1	CONNECTING A DEVICE UNDER TEST (DUT).....	61
4.2.2	CHANGING PRESSURE UNIT OF MEASURE .....	61
4.2.3	CHANGING MEASUREMENT MODE (ABSOLUTE, GAUGE).....	62
4.2.4	SETTING PRESSURES.....	62
4.2.4.1	SETTING ZERO PRESSURE .....	63
4.2.4.2	SETTING IDLE STATUS.....	63
4.2.5	PRESSURE EXERCISING THE DEVICE UNDER TEST .....	63
4.2.6	SETTING A HEAD CORRECTION .....	64
4.2.7	STOPPING PRESSURE CONTROL, ABORTING FUNCTION EXECUTION.....	64
4.2.8	SECURITY, USER RIGHTS.....	65
4.2.8.1	SETTING UP USERS AND MANAGING USER RIGHTS.....	65

4.2.8.2	CHANGING ACTIVE USER .....	66
4.2.9	PRESSURE LEAK TEST .....	66
<b>4.3</b>	<b>LOCAL OPERATION, ADCS TOOLS .....</b>	<b>67</b>
4.3.1	OVERVIEW .....	67
4.3.2	MAIN MENU .....	69
4.3.3	ADCS MAIN TOOLBARS .....	70
4.3.4	ADCS STATUS BAR.....	74
4.3.5	ADCS RUN SCREEN.....	74
4.3.5.1	ADCS RUN SCREEN CONTROL PANEL .....	75
4.3.5.2	ADCS SYSTEM DISPLAY .....	76
4.3.5.3	ADCS RUN SCREEN TOOLBAR .....	78
4.3.6	OTHER DEVICE RUN SCREENS .....	79
4.3.6.1	PG7601 PRESSURE STANDARD.....	79
4.3.6.2	FPG8601 PRESSURE STANDARD .....	80
4.3.6.3	PPC3 (FPG'S PRESSURE CONTROLLER).....	80
4.3.6.4	RPM4 REFERENCE PRESSURE MONITOR .....	81
<b>4.4</b>	<b>AUTOMATED TESTING .....</b>	<b>82</b>
4.4.1	SETTING UP TO RUN AUTOMATED TESTS .....	82
4.4.1.1	SETTING UP DEVICE UNDER TEST (DUT).....	82
4.4.1.2	SETTING UP TEST DEFINITIONS.....	84
4.4.1.3	SETTING UP SUPPORT DEVICES.....	85
4.4.1.4	TEST OPTIONS (DATA OPTIONS).....	85
4.4.2	RUNNING AUTOMATED TESTS .....	86
4.4.2.1	RUNNING A MANUAL TEST .....	87
4.4.2.2	RUNNING A TEST DEFINITION.....	87
4.4.3	TEST RUN SCREENS .....	88
4.4.3.1	DATA PLOT RUN SCREEN.....	89
4.4.3.2	DATA GRID RUN SCREEN.....	89
4.4.3.3	DUT/REFERENCE COMPARISON RUN SCREEN .....	90
4.4.4	TEST DATA.....	91
4.4.5	REPORT EDITOR .....	91
4.4.6	RUNNING A MODEL 3682 AIR DATA CALIBRATOR .....	92
4.4.6.1	RUNNING A VALIDATION (CALIBRATION) .....	92
4.4.6.2	RUNNING A STANDARDIZATION .....	97

**5. REMOTE OPERATION ..... 103**

**6. GENERAL MAINTENANCE AND ADJUSTMENTS ..... 105**

6.1	SUMMARY .....	105
6.2	FPG8601, CHECK BUBBLER AND ADD WATER IF NECESSARY.....	106
6.3	FPG8601, REMOVE CLEAN AND REINSTALL THE PISTON-CYLINDER .....	107
6.3.1	OVERVIEW .....	107
6.3.2	REMOVING THE PISTON-CYLINDER FROM THE MOUNTING POST.....	109
6.3.3	REMOVING THE PISTON FROM THE CYLINDER .....	111
6.3.4	CLEANING THE PISTON AND CYLINDER .....	112
6.3.5	PUTTING THE PISTON INTO THE CYLINDER .....	113
6.3.6	INSTALLING THE PISTON-CYLINDER IN THE MOUNTING POST .....	114
6.3.7	RESTORING PISTON-CYLINDER LUBRICATION AND MOBILITY.....	115
6.3.7.1	OVERVIEW .....	115
6.3.7.2	PISTON CENTERING AND LUBRICATING METHODS .....	115
6.4	PG7601, DISASSEMBLE PLATFORM AND REMOVE MOUNTING POST PRT.....	117
6.5	PG7601, REMOVE AND REINSTALL THE AUTOMATED MASS HANDLER AND MASS SET .....	118
6.5.1	THE MASS HANDLER (AMH) .....	118
6.5.2	THE MASS SET .....	121
6.6	PG7601, REMOVE, CLEAN AND REINSTALL THE PISTON-CYLINDER MODULE .....	122
6.6.1	REMOVING THE PISTON-CYLINDER MODULE .....	122
6.6.2	INSTALLING THE PISTON-CYLINDER MODULE .....	123
6.6.3	DISASSEMBLING THE MODULE AND CLEANING THE PISTON-CYLINDER ASSEMBLY.....	124
6.6.3.1	OVERVIEW .....	124
6.6.3.2	DISASSEMBLING AND REASSEMBLING THE MODULE .....	124
6.6.3.3	LUBRICATING THE PISTON-CYLINDER MODULE .....	127
6.6.3.4	CLEANING THE PISTON-CYLINDER .....	128
6.7	PG7601, PISTON POSITION DETECTION ADJUSTMENT .....	130
6.8	PG7601, REPLACE PISTON ROTATION DRIVE BELTS .....	131
6.9	PG7601, ADJUST INTERNAL VACUUM GAUGE.....	131

6.10	PG7601/FPG8601, ADJUST PPC3 PRESSURE CONTROLLERS.....	132
6.11	CONTROL CABINET, INTERRUPTING PRESSURE SUPPLY TO THE TEST GAS SUPPLY PORT .....	133
6.12	CONTROL CABINET, DRAIN DRIVE AIR TRAPS.....	133
6.13	CONTROL CABINET, CHECK GAS SUPPLY PANEL SETTINGS.....	133
<b>7.</b>	<b>MAINTENANCE OF TRACEABILITY AND RECALIBRATION ...</b>	<b>135</b>
7.1	PRINCIPLES OF ADCS-601-AF TRACEABILITY MAINTENANCE .....	135
7.2	LOCAL METROLOGY MAINTENANCE BETWEEN RECALIBRATIONS .....	135
7.2.1	OVERVIEW .....	135
7.2.2	FPG8601, ZERO AND ADJUST SPAN OF LOAD CELL.....	136
7.2.2.1	AUTOMATICALLY INITIATED LOAD CELL ZERO AND SPAN ADJUSTMENT.....	136
7.2.2.2	OPERATOR INITIATED LOAD CELL ZERO AND SPAN ADJUSTMENT .....	137
7.2.3	FPG8601, VALIDATE WITH PG7601 .....	137
7.2.3.1	OVERVIEW.....	137
7.2.3.2	RUNNING VALIDATION .....	138
7.2.3.3	VIEWING FPG VALIDATION DATA .....	141
7.2.4	FPG8601, CHECK ON-BOARD P, T, H MEASUREMENTS .....	141
7.2.5	FPG8601, VALIDATE LOAD CELL LINEARITY .....	141
7.2.5.1	OVERVIEW.....	141
7.2.5.2	LINEARITY VERIFICATION PROCEDURE.....	142
7.2.5.3	EVALUATING LINEARITY VERIFICATION DATA .....	142
7.2.6	FPG8601 AND PG7601, ZERO REFERENCE VACUUM CDGS .....	143
7.2.7	PG7601, ADJUST ON-BOARD P, T, H SENSORS.....	146
7.3	RECALIBRATION .....	147
7.3.1	OVERVIEW .....	147
7.3.2	PG7601, CALIBRATION OF PISTON-CYLINDER MODULE .....	148
7.3.2.1	PREPARING FOR CALIBRATION.....	148
7.3.2.2	UPDATING PISTON-CYLINDER CALIBRATION INFORMATION .....	148
7.3.3	PG7601, CALIBRATION OF MASS SET.....	149
7.3.3.1	PREPARING FOR CALIBRATION.....	149
7.3.3.2	UPDATING MASS SET CALIBRATION INFORMATION .....	150
7.3.4	PG7601, CALIBRATION OF PISTON-CYLINDER MODULE TEMPERATURE SENSOR.....	151
7.3.4.1	OVERVIEW .....	151
7.3.4.2	PROCEDURE .....	152
7.3.4.3	CALCULATING AND UPDATING PISTON-CYLINDER TEMPERATURE SENSOR INFORMATION..	152
7.3.5	PG7601, CALIBRATION OF REFERENCE VACUUM CDG .....	154
7.3.5.1	OVERVIEW .....	154
7.3.5.2	REMOVING THE CDG ASSEMBLY .....	154
<b>8.</b>	<b>TROUBLESHOOTING .....</b>	<b>157</b>
8.1	OVERVIEW .....	157
<b>9.</b>	<b>APPENDIX .....</b>	<b>159</b>
9.1	CONVERSION OF NUMERICAL VALUES.....	159
9.1.1	PRESSURE.....	159
9.2	GLOSSARY.....	160
9.3	WARRANTY STATEMENT .....	161



# TABLES

Table 1. ADCS-601-AF packing list .....	29
Table 2. Reference Bench parts list.....	30
Table 3. Interconnections kit parts list .....	31
Table 4. ADCS accessory kit parts list.....	31
Table 5. PG7601 Platform parts list.....	32
Table 6. PC-7100/7600-10, TC piston-cylinder module parts list.....	33
Table 7. MS-AMH-38 mass set parts list .....	33
Table 8. AHM-38 automated mass handler parts list .....	34
Table 9. FPG8601 Platform parts list.....	34
Table 10. MS-8601-2 mass set parts list .....	35
Table 11. Valve states.....	59
Table 12. User rights user access areas .....	65
Table 13. ADCS Tools Main Menu and sub-menus summary .....	69
Table 14. ADCS Main Toolbar buttons .....	70
Table 15. ADCS Run Screen Control Panel features.....	75
Table 16. ADCS System Display symbols.....	77
Table 17. ADCS Run Screen Toolbar.....	78
Table 18. Mechanical maintenance procedures.....	105
Table 19. PG7601 mounting post wire colors, description and location.....	117
Table 20. Gas Supply Panel pressure settings.....	133
Table 21. Metrological maintenance procedures.....	136
Table 22. FPG8601 P, T, H limits .....	141
Table 23. Recalibration requirements.....	147
Table 24. Troubleshooting checklist .....	157
Table 25. Pressure unit of measure conversions .....	159
Table 26. DHI Authorized Service Providers .....	161

# FIGURES

Figure 1. ADCS-601-AF overall, front view.....	6
Figure 2. ADCS-601-AF system pneumatic schematic .....	7
Figure 3. ADCS-601-AF simplified operational schematic .....	8
Figure 4. ADCS-601-AF system electrical schematic.....	9
Figure 5. ADCS-601-AF system communications schematic.....	10
Figure 6. ADCS-601-AF software, communications and control flow chart .....	11
Figure 7. Reference Bench, top view.....	12
Figure 8. Pneumatic Interconnections Box, bulkhead .....	13
Figure 9. Control Cabinet, front and rear views .....	14
Figure 10. Gas Supply Panel .....	15
Figure 11. Piston gauge operating principle .....	16
Figure 12. PG7601 Platform rear panel.....	17
Figure 13. PG7000 Terminal front panel .....	17
Figure 14. PG7000 Terminal rear panel .....	18
Figure 15. PG7601 10 kPa/kg piston-cylinder module .....	18
Figure 16. AMH-38 automated mass handler.....	19
Figure 17. AMH-38 operating principle schematic.....	20
Figure 18. AMH-38 mass set .....	21
Figure 19. Force balanced piston gauge operating principle.....	22
Figure 20. FPG8601 front and rear views.....	23
Figure 21. PPC3 front panel .....	24
Figure 22. PPC3 rear panel .....	25
Figure 23. RPM4 front panel.....	26
Figure 24. RPM4 rear panel.....	26
Figure 25. Turbo pump local interface panel (local control not used in regular ADCS-601-AF operation).....	28
Figure 26. Typical layout of overall ADCS-601-AF system at site of use .....	37
Figure 27. Piston-cylinder module installation .....	44
Figure 28. Local gravity and pressure medium fields in ADCS Tools .....	54
Figure 29. ADCS-601-AF simplified operational schematic .....	59
Figure 30. ADCS Tools pressure exercise definition form.....	64
Figure 31. ADCS Tools pressure leak test results form .....	67
Figure 32. ADCS-601-AF software, communications and control flow chart .....	68
Figure 33. ADCS-601-AF program window .....	68
Figure 34. ADCS Main Toolbar .....	70
Figure 35. ADCS Status Bar .....	74
Figure 36. ADCS Run Screen.....	74
Figure 37. ADCS System Display .....	78
Figure 38. PG7601 Run Screen.....	79
Figure 39. FPG8601 Run Screen .....	80
Figure 40. PPC3 Run Screen .....	81
Figure 41. RPM4 Run Screen.....	81
Figure 42. Data Plot Run Screen .....	89
Figure 43. Data Grid Run Screen .....	90
Figure 44. DUT/Reference Comparison Run Screen .....	90



---

Figure 45. FPG8601 bubbler and filter .....	106
Figure 46. FPG8601 piston-cylinder assembly in mounting post .....	108
Figure 47. Removing the FPG8601 mounting post .....	110
Figure 48. Removing the FPG8601 piston-cylinder.....	110
Figure 49. Alignment of the FPG8601 piston in the cylinder .....	113
Figure 50. AMH installation on PG7000 Platform .....	119
Figure 51. AMH mass set .....	122
Figure 52. PG7601 piston-cylinder module installation .....	123
Figure 53. 10 kPa/kg gas piston-cylinder module, expanded view .....	125
Figure 54. 10 kPa/kg piston insertion tool.....	126
Figure 55. 10 kPa/kg gas piston-cylinder module sleeve nut tool .....	126
Figure 56. 10 kPa/kg piston-cylinder module lubrication chart.....	128
Figure 57. PG7601 piston stroke and zones .....	131
Figure 58. ADCS Tools FPG Run Screen .....	137
Figure 59. ADCS Tools FPG Validation Setup Form.....	140
Figure 60. ADCS Tools FPG Validation Results Form .....	140
Figure 61. ADCS Tools CDG Zero System Display.....	146
Figure 62. PG7601 Ambient Sensors Adjust Form.....	147
Figure 63. ADCS Tools PG7601 Piston-Cylinder Calibration Form .....	149
Figure 64. ADCS Tools PG7601 AMH-38 Mass Set Calibration Form .....	151
Figure 65. ADCS Tools PG7601 Piston-Cylinder Calibration Form .....	154

## NOTES



# ABOUT THIS MANUAL

This manual provides the information necessary to operate an ADCS-601-AF Air Data Calibration Standard. The ADCS-601-AF is a system made up of several standard instruments. This manual describes the individual instruments and their operation to the extent necessary for normal operation and maintenance of the ADCS-601-AF system. More detailed information on individual instruments and software is contained in each instrument or program's specific operation and maintenance manual.

Before using the manual, take a moment to familiarize yourself with the Table of Contents structure. Set up of an ADCS-601-AF system should not be attempted without using Section 3. All first time ADCS-601-AF users should read Section 4. Section 8 is a quick troubleshooting guide. Use the information in Section 8 to troubleshoot unexpected ADCS-601-AF behavior based on the symptoms of that behavior.

Certain words and expressions have specific meaning as they pertain to ADCS-601-AF and its instruments. The Glossary (see Section 9.2) is useful as a quick reference for the definition of specific words and expressions as they are used in this manual.

## Manual Conventions



*(CAUTION) is used throughout the manual to identify user warnings and cautions.*



*(NOTE) is used throughout the manual to identify operating and applications advice and additional explanations.*

[ ] indicates direct function keys or objects (e.g., **[RANGE]**) on an instrument front panel keypad or in a software user interface.

< > indicates instrument front panel screen displays or labels in a software user interface (e.g., **<1yes>**)

## NOTES



# 1. INTRODUCTION

ADCS-601-AF is a fully automated reference level Air Data Calibration Standard for the verification and calibration of air data range instruments, in particular Air Data Test Sets (ADTS). ADCS-601-AF's intended function is the static pressure calibration of Pt and Ps range pressure transducers with very low measurement uncertainty. ADCS-601-AF is not intended to duplicate the functions of an ADTS in calibrating and testing on-board aircraft instruments.

ADCS-601-AF covers the pressure range of 1 to 380 kPa (0.3 to 120 inHg) in absolute and gauge modes with fully automated operation and state of the art uncertainty.

ADCS-601-AF is an integrated system made up of several instruments that work together under the control of ADCS Tools software running on a personal computer. Operator interaction with ADCS-601-AF is accomplished through the keyboard, pointing device and display of the system controller (personal computer).

The heart of the system is a fully automated PG7601 piston gauge or pressure balance that covers the range of 15 to 380 kPa (4.5 to 120 inHg). The PG7601 range is extended down to 1 kPa (0.3 inHg) by an FPG8601 force balanced piston gauge with automated pressure control.

## 1.1 SPECIFICATIONS

### 1.1.1 ADCS SYSTEM GENERAL SPECIFICATIONS

#### Power Requirements

Instruments (AC1)	100 to 240 VAC, 50/60 Hz, 240 W max. consumption Fuse: 250VT 10A
Reference vacuum pumps (AC2)	110 V version: 100 – 120V, 50/60 Hz, 1100 W max. consumption Fuse: 250VT 10A 220 V version: 200 – 240V, 50/60 Hz, 1100 W max. consumption Fuse: 250VT 10A
Utility pump (AC3)	110 V version: 100 – 120V, 50/60 Hz, 800 W max. consumption Fuse: 250VT 10A 220 V version: 200 – 240V, 50/60 Hz, 800 W max. consumption Fuse: 250VT 10A

#### Pressure Supply Requirements

Drive air: 0.7 to 1 MPa (100 to 150 psi)  
Test gas: Nitrogen or air, 0.45 to 1 MPa (65 to 150 psi), clean and dry (instrument grade minimum, high purity preferred)

#### Operating Temperature Range

20 to 26 °C

#### Weight

Reference bench	173 kg (380 lb) approx. (with turbo pump and controller installed)
Control cabinet	105 kg (230 lb) approx.
Utility and roughing vacuum pumps	19 kg (42 lb) each

#### Dimensions

Reference bench	145 cm H x 122 cm W x 76 cm D (57 in. x 48 in. x 30 in.)
Control cabinet	124 cm H x 56 cm W x 66 cm D (49 in. x 22 in. x 26 in.)

#### Pressure Ranges

Overall	1 to 380 kPa (0.3 to 120 inHg)
PG7601	10 to 380 kPa (3 to 120 inHg)
FPG8601	1 to 15 kPa (0.2 to 4.5 inHg)

#### Operating Medium

Nitrogen or air

#### Pressure Connections

TEST(+) port	Quick connector (1/4 in. NUPRO® SS-QC4-B1-400)
TEST(-) port	Quick connector (1/4 in. NUPRO® SS-QC4-B1-400)

#### CE Conformance

Available, must be specified.

## 1.1.2 PG7601 PISTON GAUGE SPECIFICATIONS

### 1.1.2.1 AMBIENT AND PISTON-CYLINDER CONDITION MEASUREMENTS

<b>Temperature</b>	<u>Ambient</u>	<u>Piston Cylinder Module</u>
Range	0 to 40 °C	0 to 40 °C
Resolution	0.1	0.01
Measurement Uncertainty	± 1	± 0.1
 <b>Barometric Pressure</b>		
Range	70 to 110 kPa	
Resolution	10 Pa	
Measurement Uncertainty	± 140 Pa	
 <b>Relative Humidity</b>		
Range	5 to 95 % RH	
Resolution	1 % RH	
Measurement Uncertainty	± 10 % RH	
 <b>Piston Position</b>		
Range	± 4.5 mm	
Resolution	0.1 mm	
Measurement Uncertainty	± 0.2 mm	
 <b>Piston Rotation</b> (Rate and deceleration)		
Range	2 to 99 rpm	
Resolution	1 rpm	
 <b>Reference Vacuum</b> (with on-board gauge)		
Range	0 to 20 Pa	
Resolution	0.01 Pa	
Measurement Uncertainty	± 0.1 Pa or 10 % of reading, whichever is greater	
 (with external capacitance diaphragm gauge)		
Range	0 to 13.3 Pa (100 mTorr)	
Resolution	0.001 Pa (0.01 mTorr)	
Measurement Uncertainty	± 0.05 Pa (0.38 mTorr)	

### 1.1.2.2 PISTON-CYLINDER MODULE

#### PC-7100/7600-10

Nominal pressure to mass	10 kPa/kg
Operation	Gas operated, gas lubricated
Piston material	Tungsten carbide
Cylinder material	Tungsten carbide
Nominal diameter	35 mm
Nominal area	1 000 mm <sup>2</sup>
Mounting system	Positive free deformation
Typical drop rate	0.2 mm/min
Piston assembly nominal mass	0.5 kg

### 1.1.2.3 MASS SET

#### Masses > 50g

Material	304L non-magnetic stainless steel
Finish	Electropolished
Uncertainty in measured values	± 5 ppm or 1 mg, whichever is greater

## 1.1.3 FPG8601 GENERAL SPECIFICATIONS

### 1.1.3.1 AMBIENT AND PISTON-CYLINDER CONDITION MEASUREMENTS

Temperature:	Lubrication Gas	Piston-Cylinder
	[°C]	[°C]
Range	0 to 40	0 to 40
Resolution	0.1	0.01
Accuracy	± 0.2	± 0.1

#### Relative Humidity:

Range	5 to 95 %RH
Resolution	1 %RH
Accuracy	± 10 %RH

#### Vacuum:

Range	13.3 Pa (100 mTorr)
Resolution	0.001 Pa (0.01 mTorr)
Accuracy	± 0.06 Pa (0.45 mTorr)

#### Ambient and Lubrication

##### Pressure Sensor:

Range	200 kPa
Resolution	1 Pa
Accuracy	± 0.1 kPa

## 1.1.4 PRESSURE MEASUREMENT AND CONTROL SPECIFICATIONS

### 1.1.4.1 10 TO 380 KPA, PG7601 AND PPC3-700K

Sensitivity <sup>1</sup>	0.02 Pa + 0.5 ppm
Precision <sup>2</sup>	± (0.01 Pa + 2 ppm)
Measurement uncertainty <sup>3</sup>	see the piston-cylinder calibration report and current revision of DHI Technical Note 7920TN01.
Control set point increments	1 kPa
Stability of set pressure	± 1 Pa
Typical control set point time	60 to 180 seconds

1 Sensitivity: The smallest variation in input detectable in output.

2 Precision: Combined linearity, hysteresis, repeatability.

3 Measurement uncertainty: Maximum deviation of the indicated pressure from the true value of applied pressure including all sources of uncertainty combined and expanded (k=2) following the ISO "Guide to the Expression of Uncertainty in Measurement."

### 1.1.4.2 1 TO 15 KPA, FPG8601 AND PPC3-100K

Resolution <sup>1</sup>	0.01 Pa
Precision <sup>2</sup>	± (2 ppm + 50 mPa)
Measurement uncertainty <sup>3</sup>	± 0.008% of reading or 0.3 Pa (0.0001 inHg) , whichever is larger
Control set point increments	1 Pa
Stability of set pressure	± 1 Pa (0.0003 inHg)
Typical control set point time	60 to 180 seconds

1 Resolution: Minimum display increment.

2 Precision: Combined linearity, hysteresis, repeatability.

3 Measurement uncertainty: Maximum deviation of the indicated pressure from the true value of applied pressure including all sources of uncertainty combined and expanded (k=2) following the ISO "Guide to the Expression of Uncertainty in Measurement." Note: The uncertainty assigned to the FPG8601 used in an ADCS-601-AF system is expanded relative to the standard FPG8601 instrument. to allow validation by the PG7601 and an indefinite recalibration interval. See Section 7.2.3 and DHI Technical Note 2090TN05.





## 2. SYSTEM OVERVIEW

### 2.1 ADCS-601-AF SYSTEM

ADCS-601-AF is a fully automated reference level Air Data Calibration Standard for the verification and calibration of air data range instruments, in particular Air Data Test Sets (ADTS). ADCS-601-AF's intended function is the static pressure calibration of Pt and Ps range pressure transducers. To this end, the system automatically sets pressure values with very low measurement uncertainty in the range of 1 to 380 kPa (0.3 to 120 inHg) in absolute and gauge modes. ADCS-601-AF is not intended to duplicate the functions of an ADTS.

The ADCS-601-AF system is made up of two automated pressure standards with overlapping ranges to cover the full pressure range. An automated PG7601 piston gauge covers the range of 15 to 380 kPa (4.5 to 120 inHg) (see Section 2.2.1). The PG7601 range is extended down to 1 kPa (0.3 inHg) by an FPG8601 force balanced piston gauge with automated pressure control (see Section 2.2.2). The system also includes vacuum pumps and vacuum measurement instruments to support absolute mode operation. An RPM4 Reference Pressure Monitor is included to assist in performing a comparison of the FPG8601 and PG7601 pressure standards.

Physically, the ADCS-601-AF system is divided into two major components (see Figure 1). The Reference Bench (see Section 2.1.1) is a laboratory table onto which are installed the PG7601 and FPG8601 pressure standards, pneumatic control switching hardware and the reference vacuum pumping systems. The Control Cabinet (see Section 2.1.2) contains the PPC3 automated pressure controllers, RPM4 Reference Pressure Monitor and Gas Supply Panel (see Section 2.1.3). The system controller (personal computer) is connected to the system by a USB interface hub (See Figure 5).

The ADCS-601-AF system is controlled by **ADCS Tools** software running on a personal computer (see Section 4.3.1). **ADCS Tools** manages the entire system, communicating with other software programs and system instruments. **ADCS Tools** also provides the overall system interface through the personal computers display, keyboard and pointing device.

See the following figures in this section describing the overall ADCS-601-AF system:

Figure 1. ADCS-601-AF overall, front view

Figure 2. ADCS-601-AF system pneumatic schematic

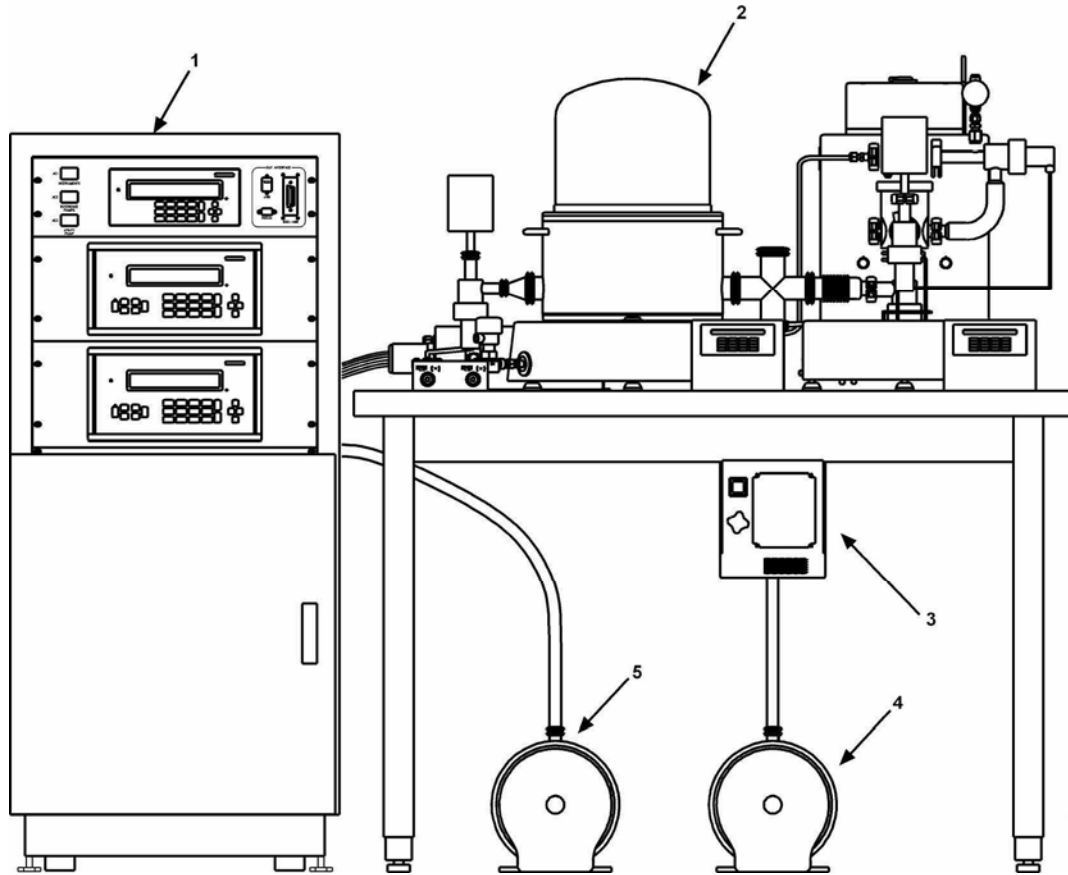
Figure 3. ADCS-601-AF simplified operational schematic

Figure 4. ADCS-601-AF system electrical schematic

Figure 5. ADCS-601-AF system communications schematic

Figure 6. ADCS-601-AF software and communications, flow chart

Figure 7. Reference Bench, top view



- 1. Control cabinet
- 2. Reference bench
- 3. Turbo pump controller and reference turbo pump (behind controller)

- 4. Reference roughing vacuum pump
  - 5. Utility vacuum pump
- Note: System controller (PC), display and keypad not shown

**Figure 1.** ADCS-601-AF overall, front view

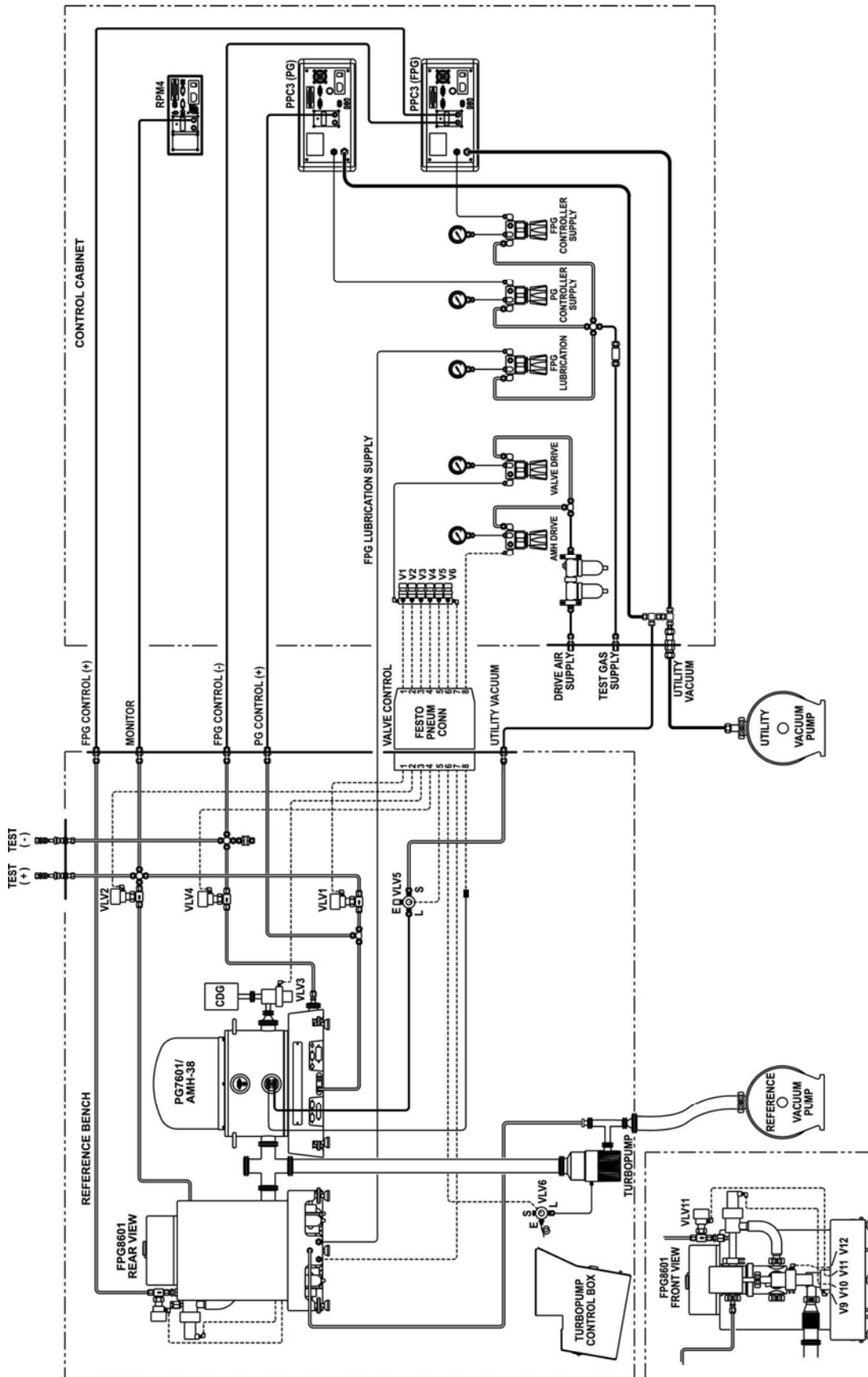


Figure 2. ADCS-601-AF system pneumatic schematic

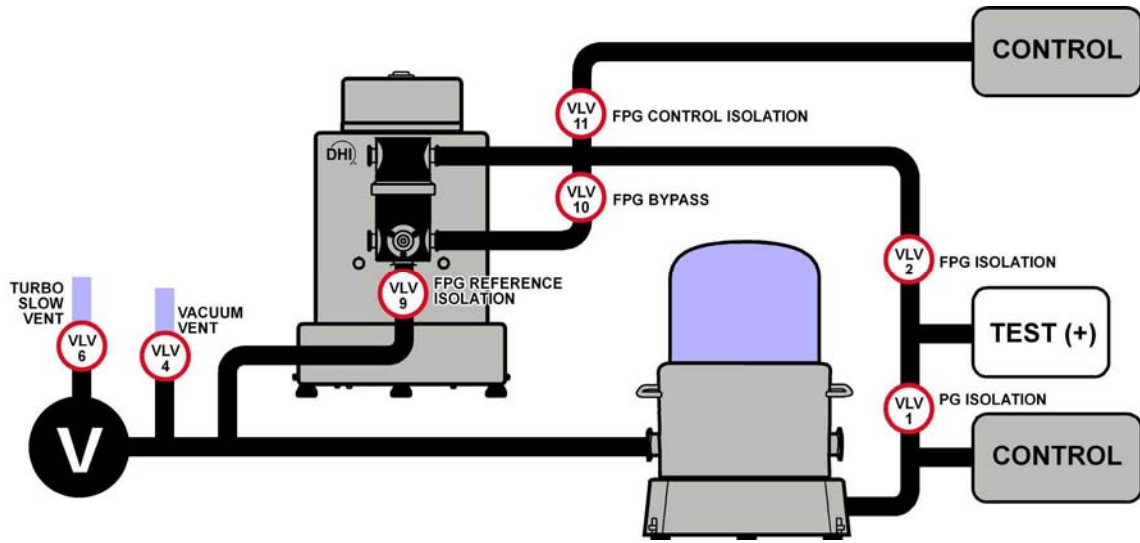


Figure 3. ADCS-601-AF simplified operational schematic

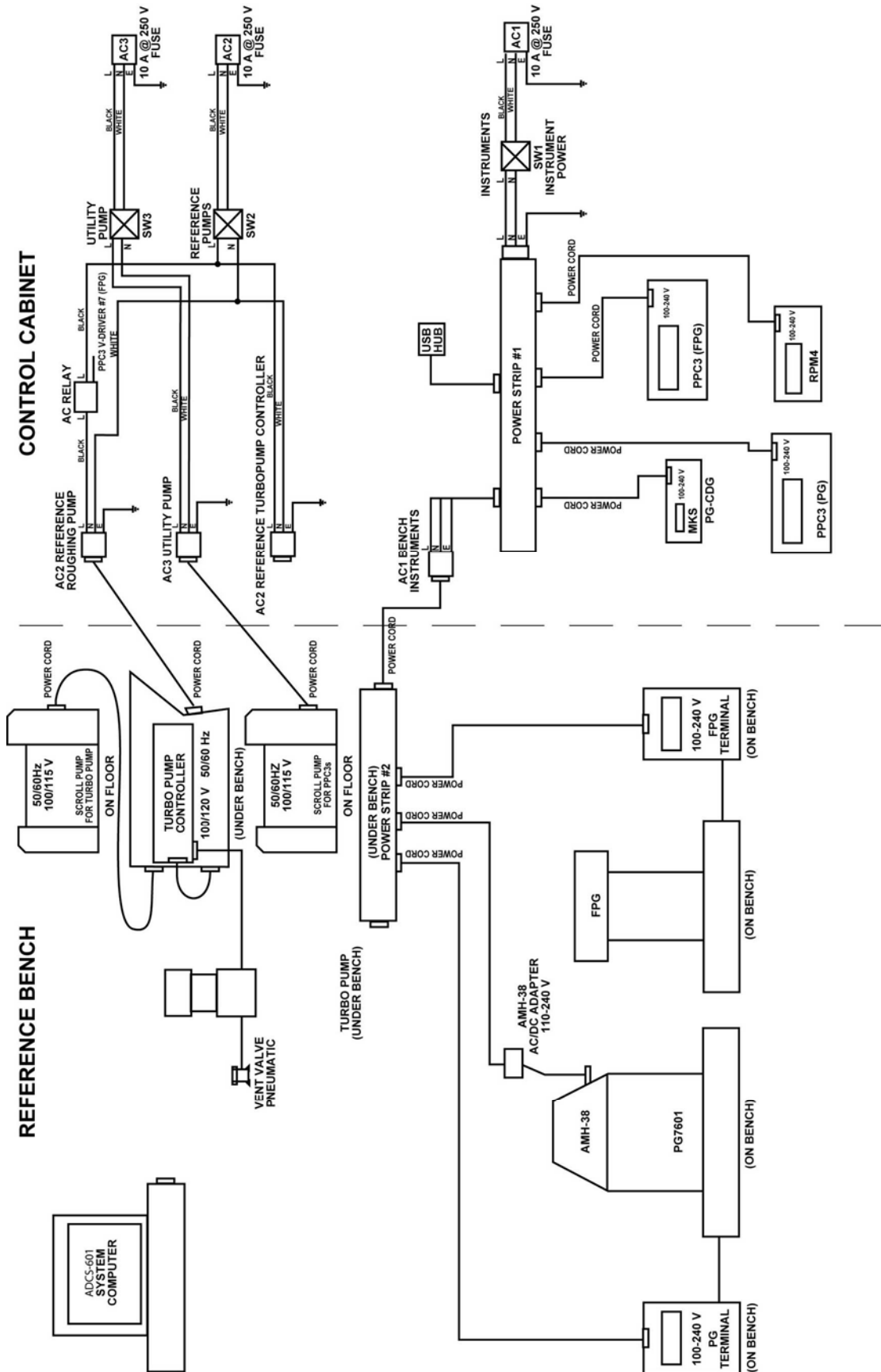


Figure 4. ADCS-601-AF system electrical schematic

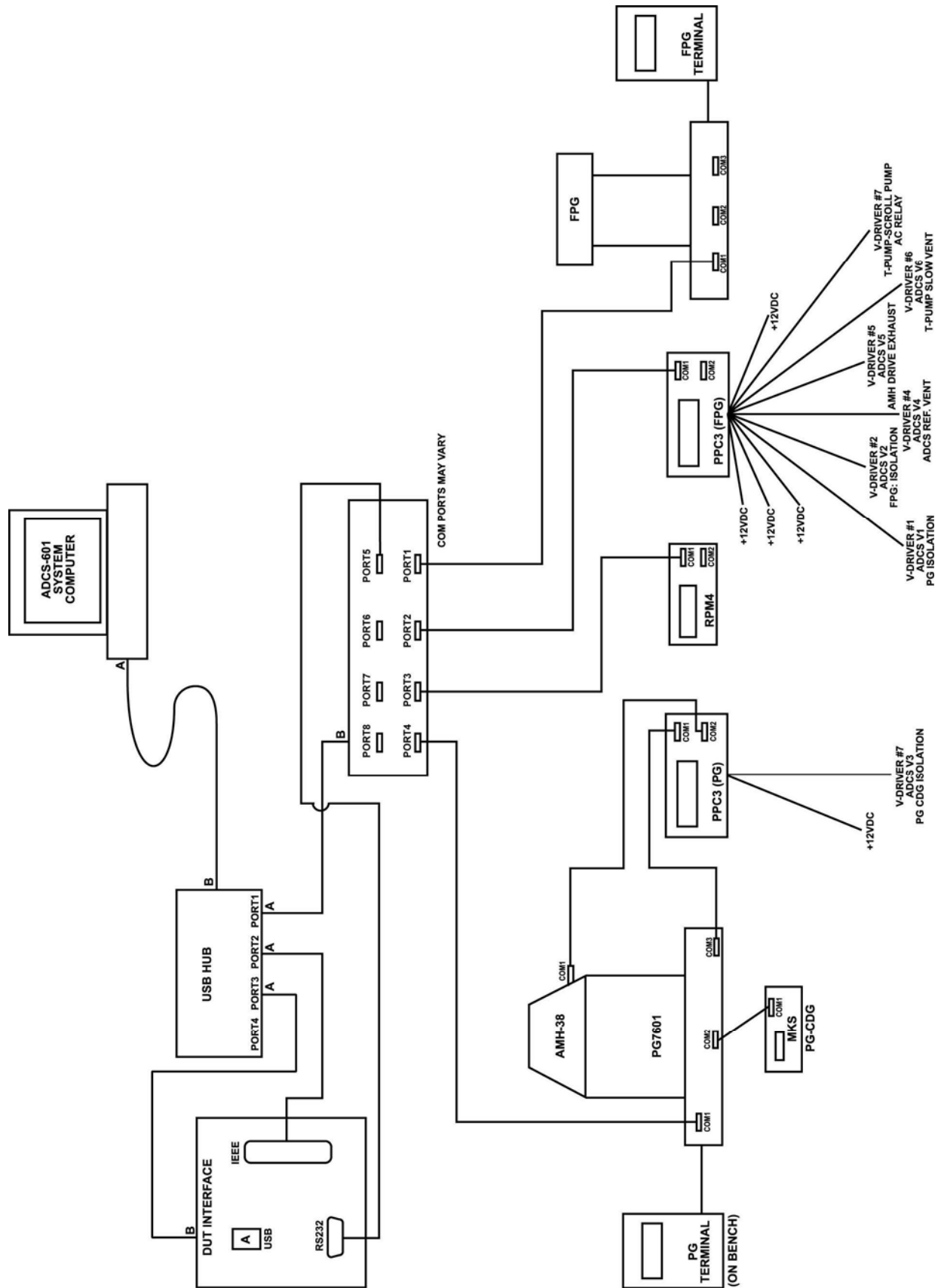


Figure 5. ADCS-601-AF system communications schematic

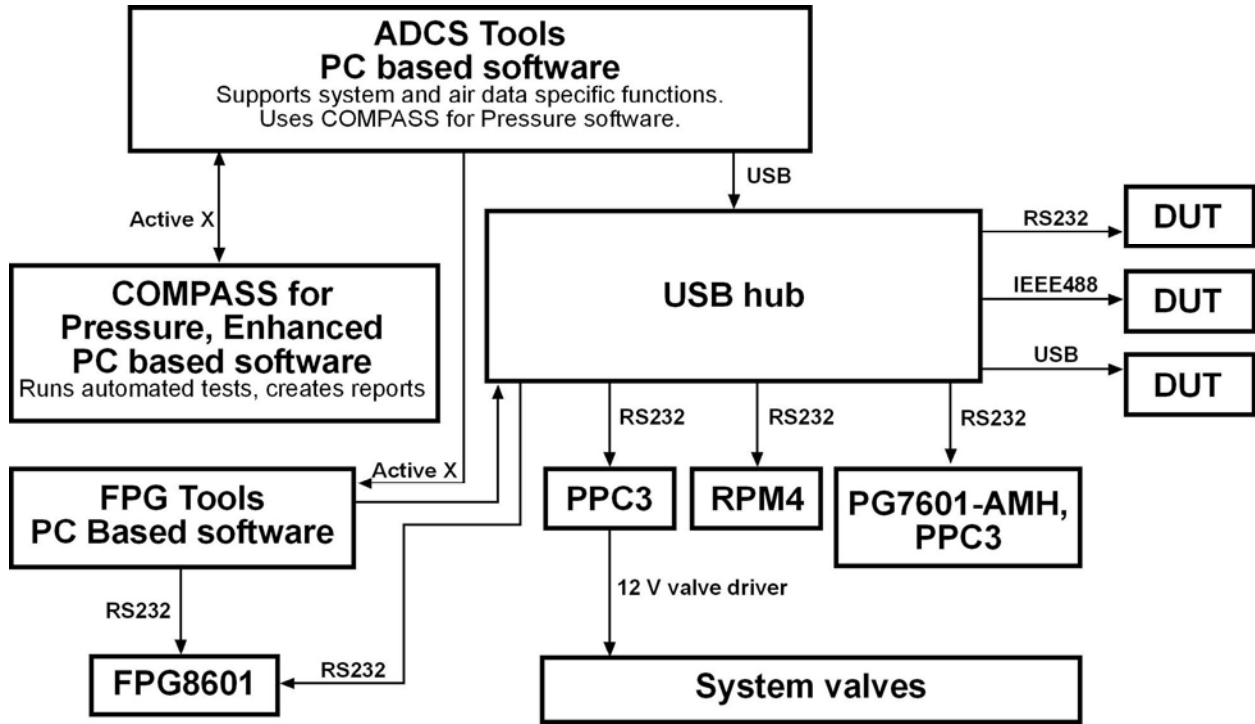
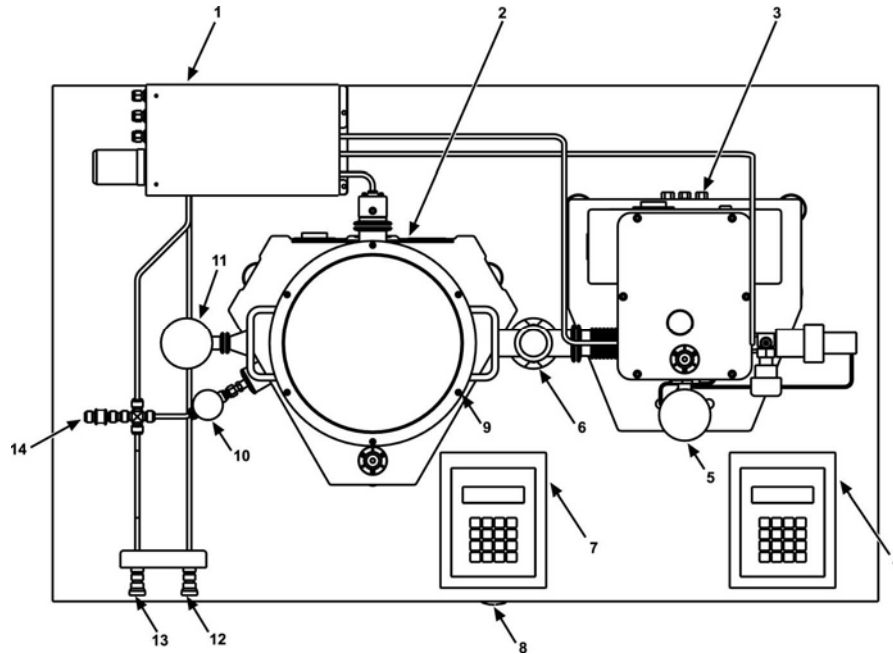


Figure 6. ADCS-601-AF software, communications and control flow chart

## 2.1.1 REFERENCE BENCH

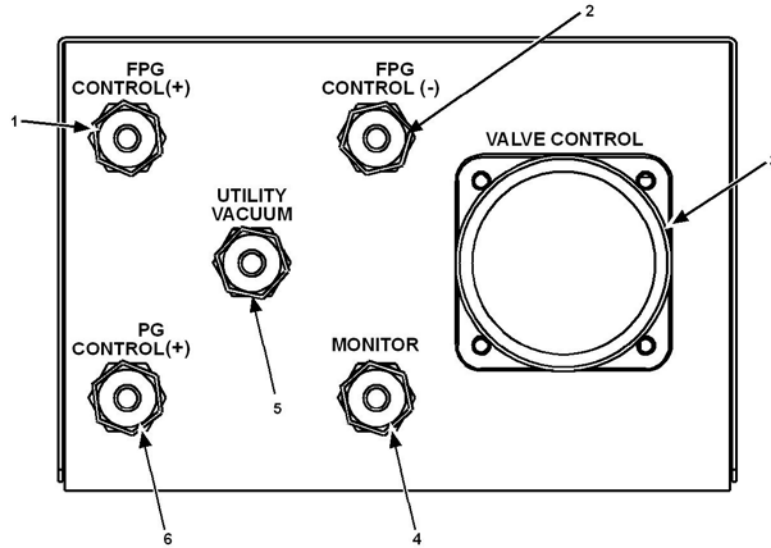
The ADCS-601-AF Reference Bench is a wooden topped laboratory work bench onto which are installed the PG7601 and FPG8601 pressure standards. Also included on the bench is a pneumatic interconnections box (see Figure 8), the system connections to the device under test (DUT) and the pumping system for the reference vacuum against which absolute pressure is defined.



- |   |   |
|---|---|
| 1. Pneumatic interconnections box   | 9. AMH-38 automated mass handler  |
| 2. PG7601 piston gauge  | 10. Reference vacuum vent valve   |
| 3. FPG8601 force balanced piston gauge  | 11. PG reference vacuum CDG   |
| 4. FPG Terminal   | 12. Pressure Connection, <b>TEST (+)</b> (connect absolute pressure tests and "high" side of differential pressure tests) |
| 5. FPG reference vacuum CDG   | 13. Pressure Connection, <b>TEST (-)</b> (connect low side of differential pressure tests)                                |
| 6. Reference vacuum manifold  | 14. Reference connection to atmosphere for gauge mode operation   |
| 7. PG Terminal  |   |
| 8. Reference turbo pump and controller, reference roughing vacuum pump, utility vacuum pump |   |

**Figure 7.** Reference Bench, top view



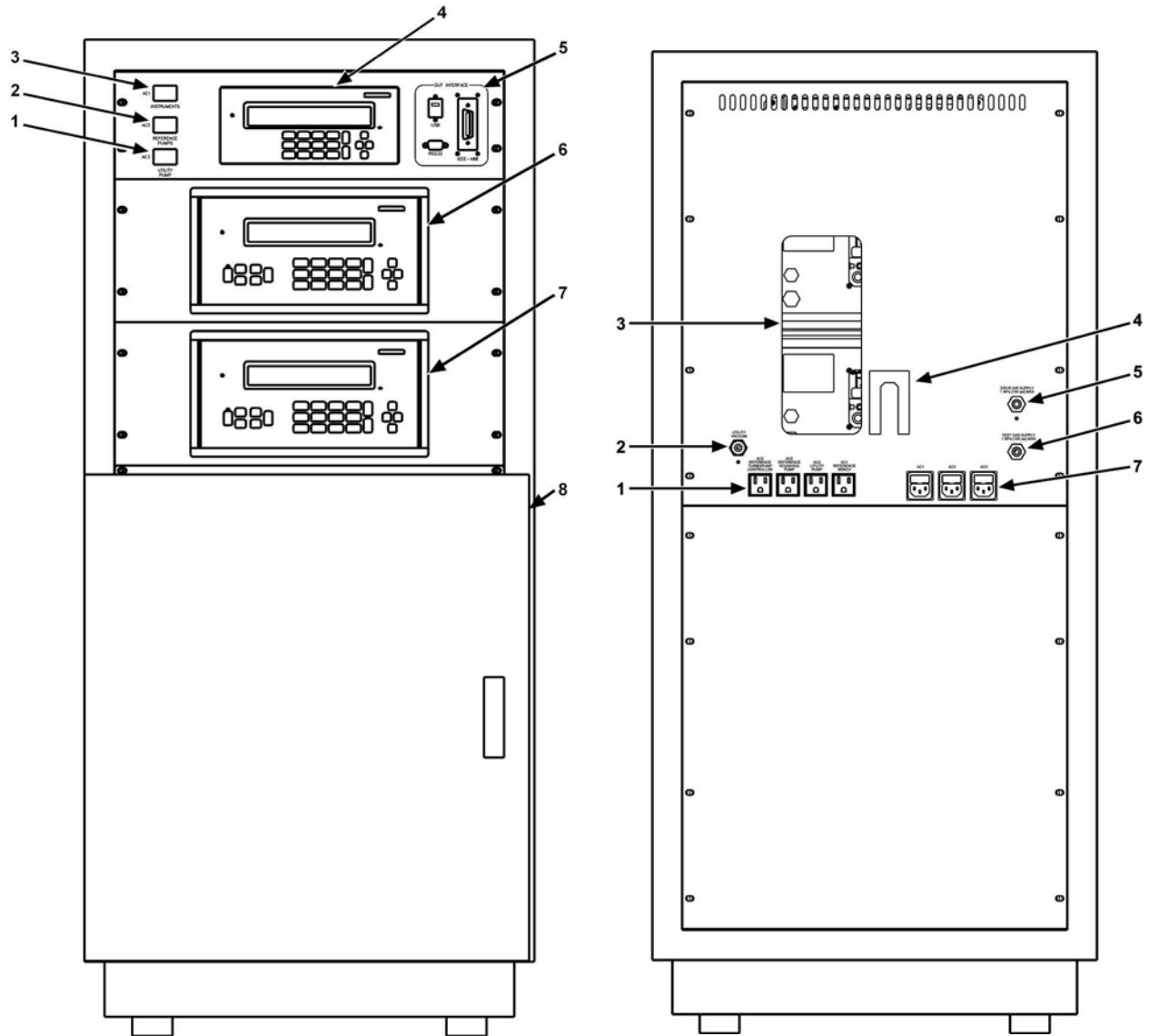


1. Connection to FPG8601's PPC3 pressure controller **TEST(+)** port in control cabinet, 1/4 in. SWG
2. Connection to FPG8601's PPC3 pressure controller **TEST(-)** port in control cabinet, 1/4 in. SWG
3. Connection to valve driver manifold in control cabinet, (8) channel pneumatic
4. Connection to RPM4 **TEST(+)** port in control cabinet, 1/4 in. SWG
5. Connection to utility vacuum source, 1/4 in. SWG
6. Connection to PG7601's PPC3 pressure controller **TEST(+)** port in control cabinet, 1/4 in. SWG

**Figure 8.** Pneumatic Interconnections Box, bulkhead

## 2.1.2 CONTROL CABINET

The ADCS-601-AF Control Cabinet is a 19 inch rack mount enclosure into which are mounted the PPC3 pressure controllers that provide automated pressure control for the PG7601 and FPG8601 pressure standards and an RPM4 Reference Pressure Monitor used to perform the validation comparison of the PG7601 and FPG8601 (see Figure 9). Also included in the control cabinet are electrical power connections and a Gas Supply Panel (see Section 2.1.3) which sets and indicates gas pressure supplies to various parts of the system.



1. Main power switch for utility vacuum pump (AC3)
2. Main power switch for reference vacuum roughing pump, turbo pump and turbo pump controller (AC2)
3. Main power switch for all instruments (AC1)
4. RPM4 used in comparison to validate FPG8601 with PG7601
5. Connections for remote communication with device under test (RS232, USB, IEEE-488)
6. PPC3 pressure controller for PG7601 system
7. PPC3 pressure controller for FPG8601 system
8. Access door to Gas Supply Panel

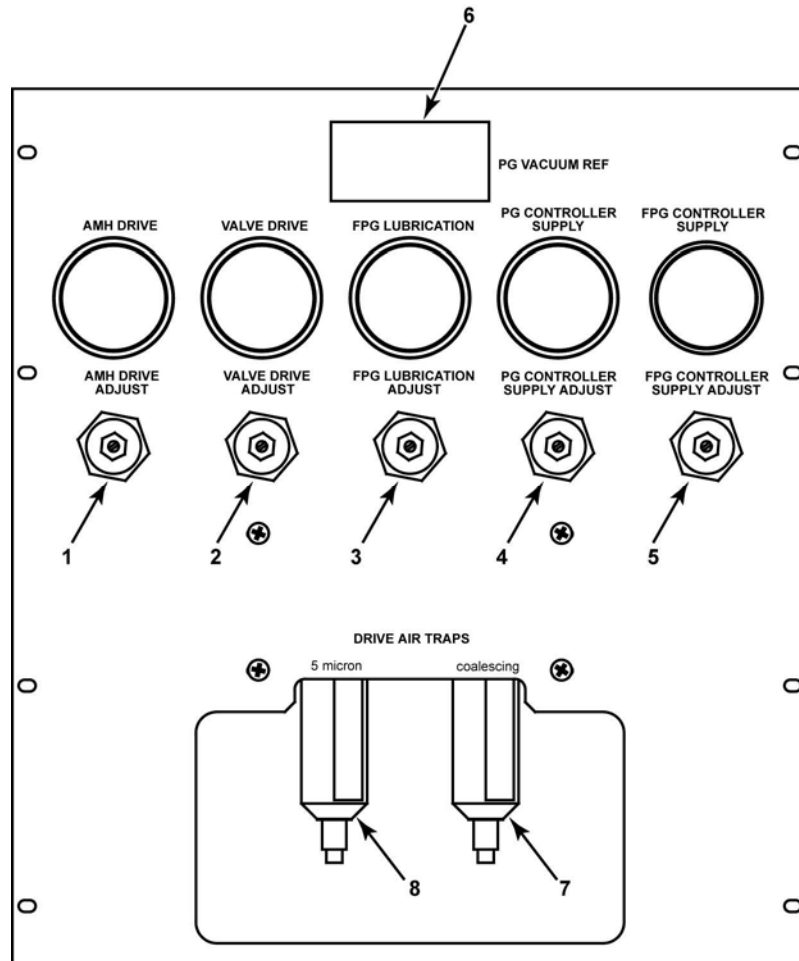
1. Power sockets for system components
2. Utility vacuum supply connection (1/4 in. NPT F)
3. Control Cabinet connections pass through and storage
4. Power cable holder for stress relief
5. Drive air supply connection (1/4 in. NPT F)
6. Test gas supply connection (1/4 in. NPT F)
7. Power supply connections (IEC-320-C13)

**Figure 9.** Control Cabinet, front and rear views

### 2.1.3 GAS SUPPLY PANEL

The Gas Supply Panel is in the ADCS-601-AF Control. It is accessed by a door in the lower part of the front of the Control Cabinet (see Figure 9).

The Gas Supply Panel is used to set and indicate gas pressure supplies to various ADCS-601-AF systems and components (see Figure 10).



- |   |  |
|---|--|
| 1. Regulator and gauge to set PG7601's AMH (automated mass handler) drive air pressure. | 4. Regulator and gauge to set pressure supply to the PG7601 system's PPC3 pressure controller  |
| 2. Regulator and gauge to set drive pressure for system pneumatically actuated valves.  | 5. Regulator and gauge to set pressure supply to the FPG8601 system's PPC3 pressure controller |
| 3. Regulator and gauge to set FPG8601 piston-cylinder purge pressure supply             | 6. Gas supply panel gauges and regulators  |
|   | 7. Drive air supply 5 micron filter trap   |
|   | 8. Drive air supply coalescing filter trap   |

\*See Section 6.13 for regulator set values

**Figure 10.** Gas Supply Panel

## 2.2 PRESSURE STANDARDS

### 2.2.1 PG7601 PISTON GAUGE

The heart of the ADCS-601-AF Air Data Calibration Standard is a PG7601 gas operated piston gauge. The PG7601 piston gauge system includes:

- PG7601 piston gauge platform with terminal (on reference bench)
- PC-7600/7100-10, TC 10 kPa/kg piston-cylinder module (mounted in platform)
- MS-AMH-38, 38 kg mass set (installed on platform)
- AMH-38-VAC, automated mass handler (installed on platform)
- CDG-VAC-REF, capacitance diaphragm gauge with display and isolation valve for measurement of PG7601 reference vacuum in absolute mode (installed on platform)
- PPC3-700K pressure controller to automate PG7601 system pressure control (in control cabinet).



The PG7601 piston gauge, AMH-38 automated mass handler and PPC3-pressure controller are stand alone products for which separate Operation and Maintenance manuals are available with much more complete information than is included in this manual. Copies of these manuals are provided on the ADCS-601-AF Support CD and are available at [www.dhstruments.com](http://www.dhstruments.com).

The PG7601 operates on the principle of the piston gauge in which pressure is defined by balancing it against a known force on a known area (see Figure 11). The known area is defined by a vertically mounted piston rotating in a cylinder and the known force is applied to the piston by loading it with known mass subjected to acceleration due to gravity. When the force applied by the pressure and the force applied by the mass accelerated by gravity are in equilibrium, the piston floats and the pressure under the piston remains constant. The pressure can be calculated following the equation in Figure 11. The pressurized fluid under the piston also lubricates the gap between the piston and the cylinder. When floating, the piston must be rotating to keep it well centered in the cylinder.

The PG7601 is equipped with a 10 kPa/kg piston-cylinder module and 38 kg mass set, giving it a range of 10 to 380 kPa (3 to 120 inHg). The PG7601 Platform includes a bell jar that can be evacuated with a vacuum pump so that pressure can be defined against vacuum (absolute mode) or atmosphere (gauge mode). The AMH-38 mass handler allows the mass load to be changed automatically. The PPC3 pressure controller adjusts pressure automatically to float the piston (see Section 2.2.3).

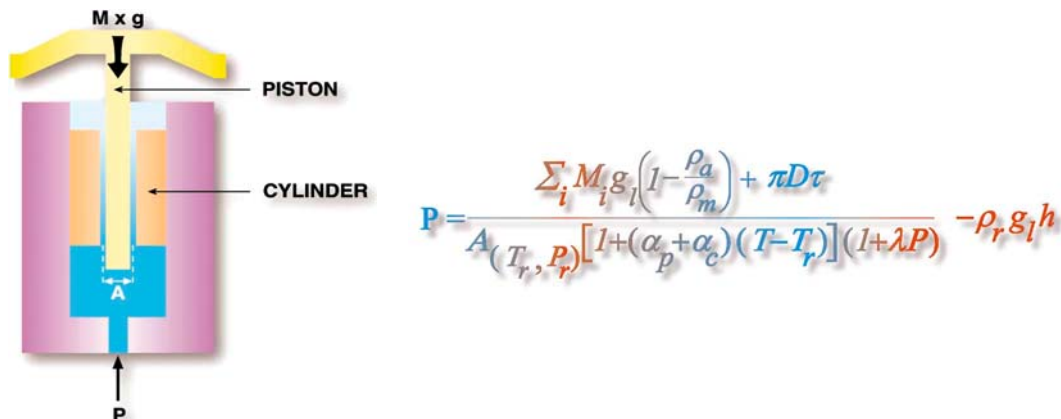


Figure 11. Piston gauge operating principle

2.2.1.1 PG7601 PLATFORM

The PG7601 Platform is the instrument base into which the piston-cylinder onto which the masses are loaded is mounted. The platform also includes the PG7601's electronic measurement system.

The PG7601 Platform rear panel provides the connection to the PG Terminal, remote communication connections and pressure connection ports.

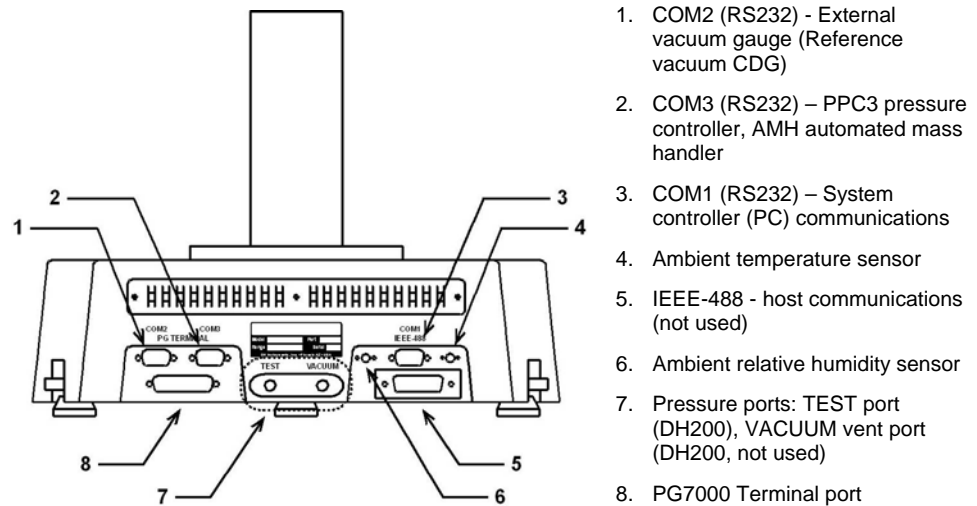


Figure 12. PG7601 Platform rear panel

2.2.1.2 PG7601 TERMINAL

The PG7000 Terminal contains the PG7601 power supplies. It also provides a local user interface through a 2 x 20 vacuum fluorescent display and 4 x 4 membrane keypad. Local commands to PG7601 are not used in normal ADCS-601-AF operation. See the PG7000 Operation and Maintenance manual for details on local operation of PG7000.

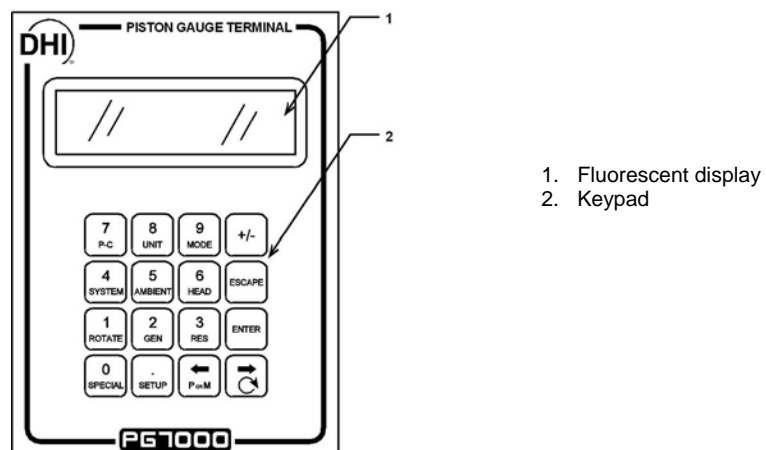


Figure 13. PG7000 Terminal front panel

The PG7000 Terminal rear panel assembly provides the communications connection to the PG7000 Platform and the power connection module.

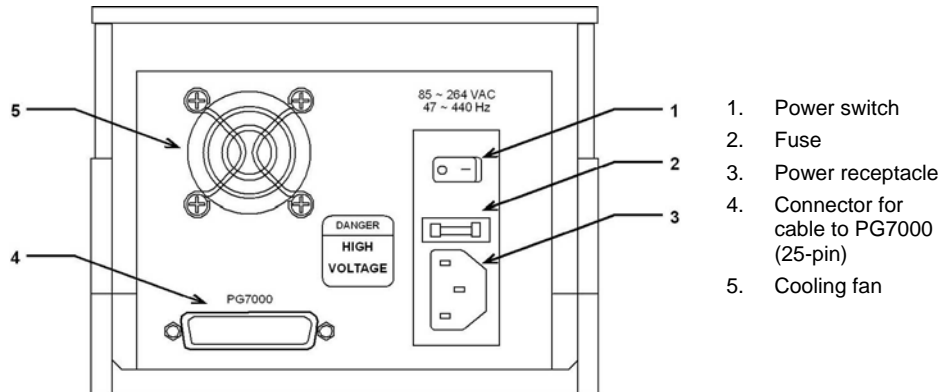


Figure 14. PG7000 Terminal rear panel

### 2.2.1.3 PG7601 10 KPA/KG PISTON-CYLINDER MODULE

The piston-cylinder module is mounted in the PG7601 Platform (see Section 2.2.1.1) and performs the pressure to force conversion.



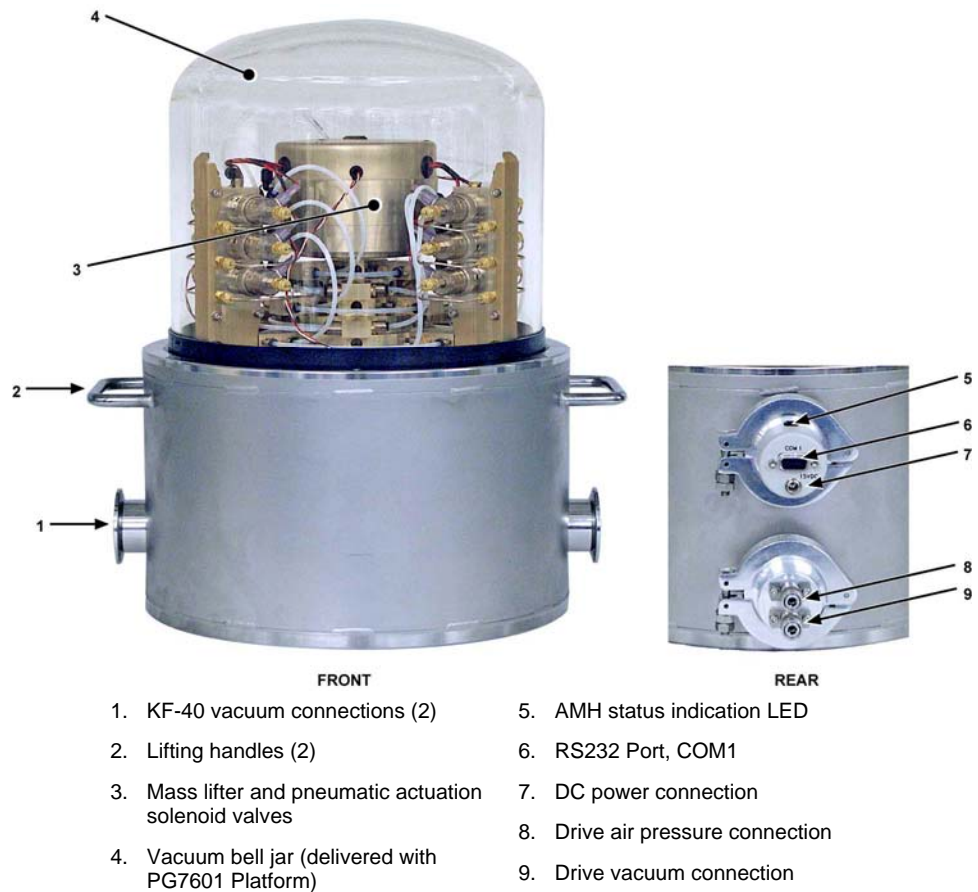
Figure 15. PG7601 10 kPa/kg piston-cylinder module

## 2.2.1.4 AMH-38 AUTOMATED MASS HANDLER

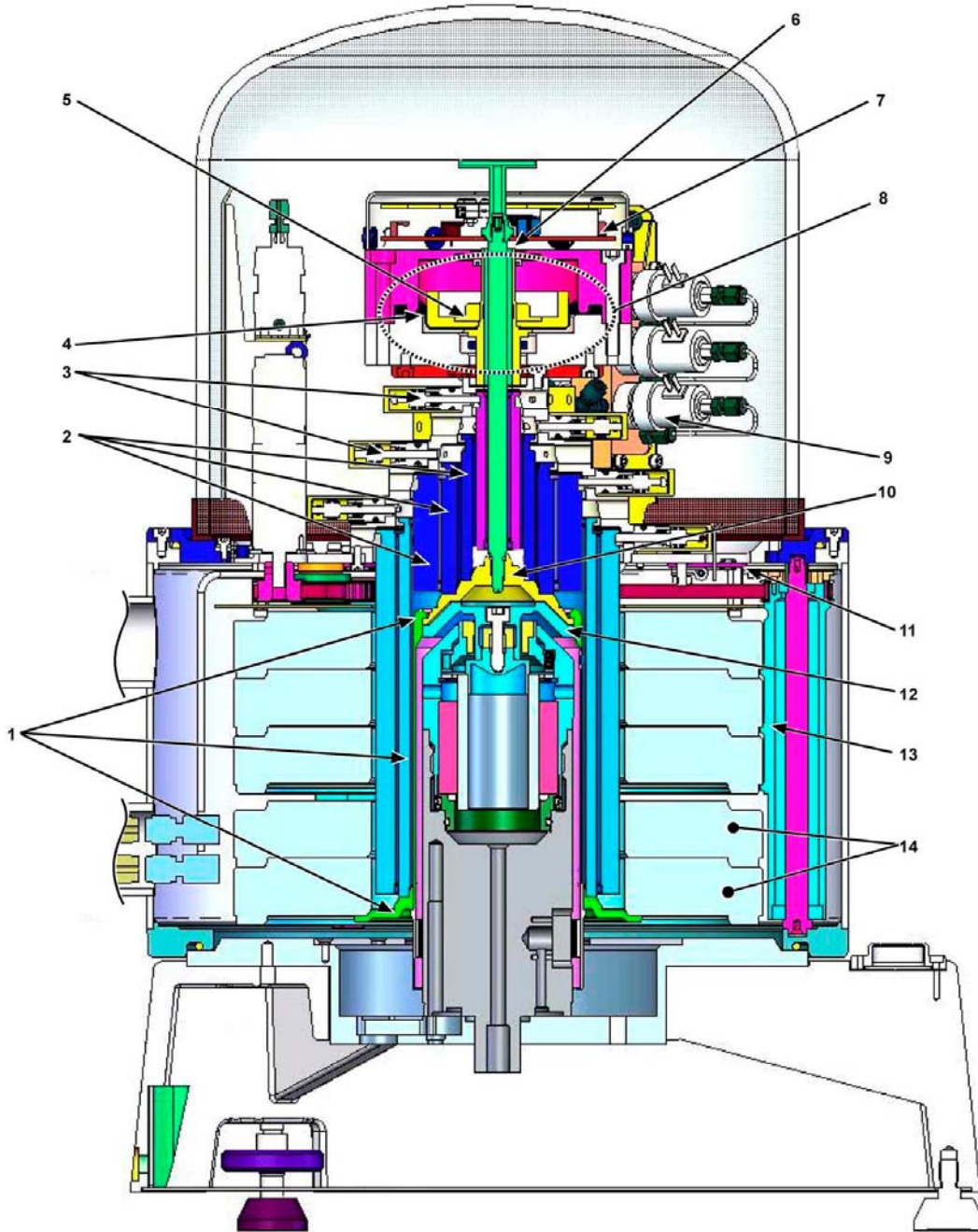
The AMH-38 automated mass handler is mounted on the PG7601 Platform (see Section 2.2.1.1) and serves to automatically change the mass load on the piston-cylinder to set different values of pressure.



The AMH-38 automated mass handler is a stand alone product for which a separate Operation and Maintenance manual is available with much more complete information than is included in this manual. A copy of the AMH manual is provided on the ADCS-601-AF Support CD and is available at [www.dhstruments.com](http://www.dhstruments.com).



**Figure 16.** AMH-38 automated mass handler



- |  |                                    |
|--|------------------------------------|
| 1. Mass loading bell                   | 8. Mass lifter                     |
| 2. Binary mass tubes                   | 9. Solenoid valve                  |
| 3. Binary mass selection pins          | 10. Binary mass carrier            |
| 4. Flexible diaphragm                  | 11. Main mass column rotation belt |
| 5. Mass lifting assembly               | 12. Piston cap                     |
| 6. Lifting ledge on mass lifting shaft | 13. Main mass column               |
| 7. Electronics and electrical controls | 14. Main masses                    |

**Figure 17.** AMH-38 operating principle schematic



### 2.2.1.5 AMH-38 MASS SET

The masses of the 38 kg mass set are loaded onto in the piston-cylinder as required to apply a force corresponding the the set pressure desired. The AMH-38 mass handler (see Section 2.2.1.4) loads and unloads the masses automatically.



Figure 18. AMH-38 mass set

## 2.2.2 FPG8601 FORCE BALANCED PISTON GAUGE

The ADCS-601-AF Air Data Calibration Standard includes an FPG8601 force balanced piston gauge to cover the air data pressure range below the range of the PG7601 gas operated piston gauge. The FPG8601 system includes:

- FPG8601 piston gauge platform with terminal and 10 kPa/kg piston-cylinder (installed on Reference Bench).
- Capacitance diaphragm gauge with display and isolation valve for measurement of FPG8601 reference vacuum in absolute mode (mounted on platform).
- PPC3-100K A116Ks/BG15Ks, pressure controller to automate FPG8601 system pressure control (see Section 2.2.3) (in control cabinet).
- MS-8601-2, 2 kg mass set with hanger for validation of FPG8601 load cell linearity. (accessory used separately in metrological maintenance (see Section 7.2.5)).



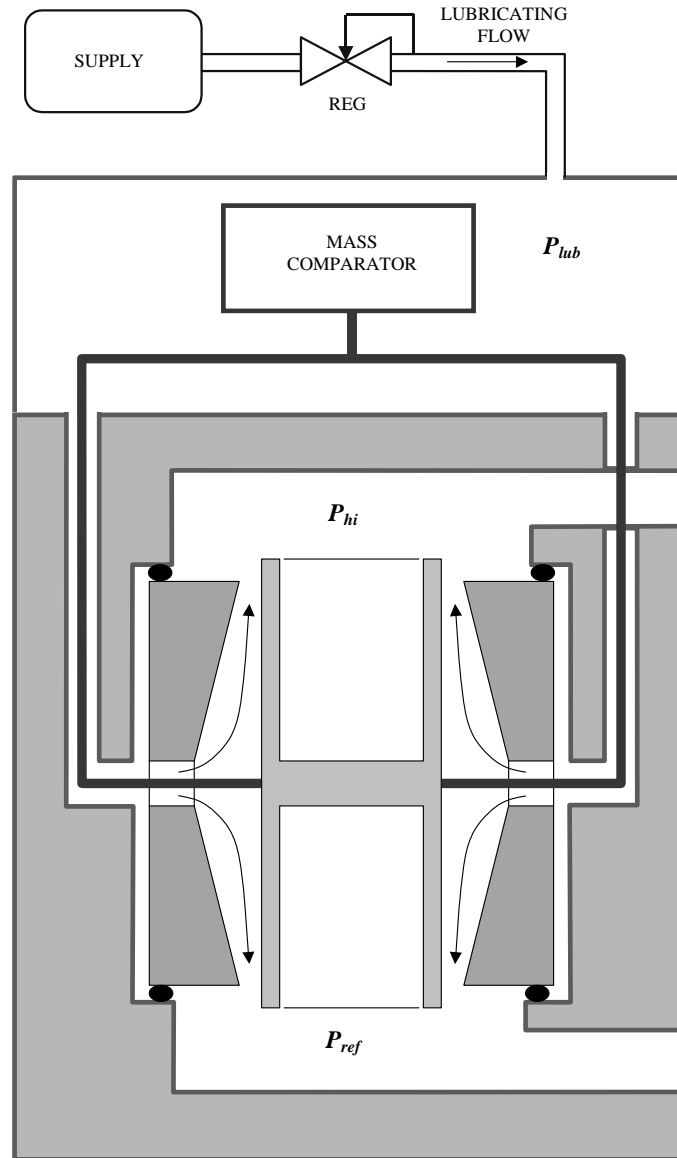
*The FPG8601 force balanced piston gauge and PPC3 pressure controller are stand alone products for which separate Operation and Maintenance manuals are available with much more complete information than is included in this manual. A copy of the FPG8601 manual is provided on the ADCS-601-AF Support CD and is available at [www.dhstruments.com](http://www.dhstruments.com).*

The FPG8601 operates on the principle of the piston gauge (see Section 2.2.1); however, the force resulting from a difference in pressure across the piston is measured by a force balanced, load cell rather than balanced directly against masses subjected to the acceleration due to gravity (see Figure 11). The piston-cylinder is suspended from the load cell. Rather than rotating the piston in the cylinder, the piston-cylinder gap is conical and gas flow through the gap is used to center the piston. The force across the piston is transmitted to the load cell through a coupling system. There are two independent chambers at either end of the piston-cylinder. The lower chamber is held at atmosphere or vacuum while the pressure to be measured is applied to the upper chamber. The load cell is zeroed with a pressure difference of zero across the piston (bypass open), taring out the weight of the piston and coupling and other parasitic forces. Then, with the pressure bypass between the

two chambers closed, the net force resulting from the difference in pressure between the two chambers is transmitted to the load cell through the coupling. The value of the pressure is calculated from the effective area of the piston-cylinder and the net force value measured by the load cell. The 10 kPa/kg piston-cylinder combined with 1.5 kg net measurement span of the load cell give the FPG8601 a pressure range of 0 to 15 kPa (4.5 inHg).

The FPG8601 Platform is interfaced with the system controller (PC) running FPG Tools software that calculates pressure and controls the FPG8601 functions.

The PPC3 pressure controller is used to automate pressure control to set the pressure measured by the FPG8601.



**Figure 19.** Force balanced piston gauge operating principle

## 2.2.2.1 FPG8601 PLATFORM

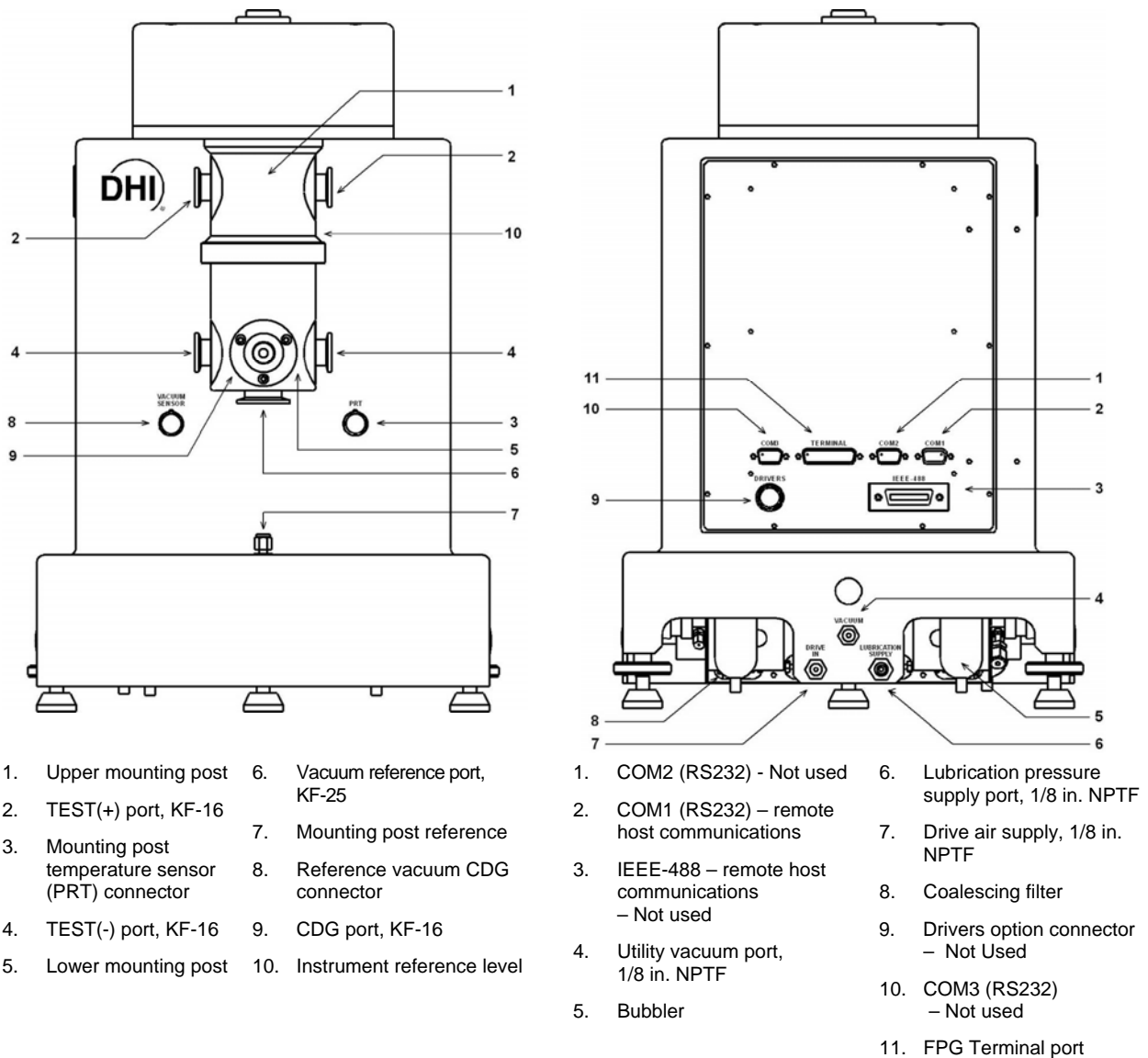


Figure 20. FPG8601 front and rear views

## 2.2.3 PPC3 PRESSURE CONTROLLERS

The ADCS-601-AF system includes two PPC3 pressure controllers that are installed in the Control Cabinet (see Section 2.1.2). One of the pressure controllers is used to automate pressure control for the PG7601 piston gauge system (see Section 2.2.1). The other is used to automate pressure control of the FPG8601 force balanced piston gauge system.

The two pressure controllers are:

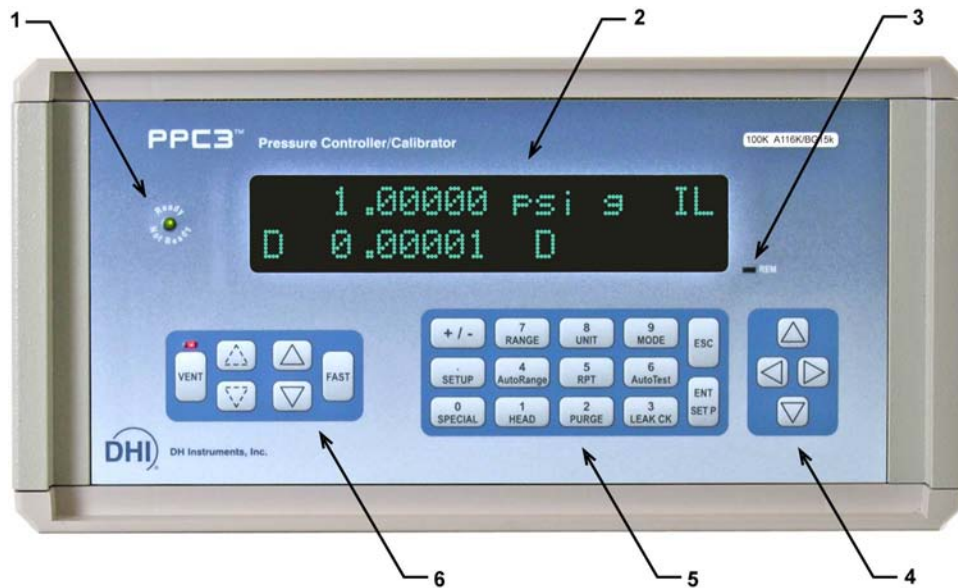
- PPC3-700K – for the PG7601 piston gauge system.
- PPC3-100K A116Ks/BG15Ks with special very low pressure control option for the FPG8601 force balanced piston gauge system.



The PPC3 pressure controllers are stand alone products for which a separate Operation and Maintenance manual is available with much more complete information than is included in this manual. A copy of the PPC3 manual is provided on the ADCS-601-AF Support CD and is available at [www.dhinstruments.com](http://www.dhinstruments.com).

The PPC3 pressure controller uses on/off solenoid valves and internal high precision pressure transducers to adjust and stabilize pressure precisely in response to remote commands.

The PPC3 front panel provides a local user interface and display for the PPC3 Pressure Controller. Local commands to PPC3s are not used in normal ADCS-601-AF operation. See the PPC3 Operation and Maintenance manual for details on local operation of PPC3.



- |                              |                                 |
|------------------------------|---------------------------------|
| 1. Ready/Not ready indicator | 4. Cursor control keys          |
| 2. Display                   | 5. Multi-function keypad        |
| 3. Remote activity indicator | 6. Direct pressure control keys |

**Figure 21.** PPC3 front panel

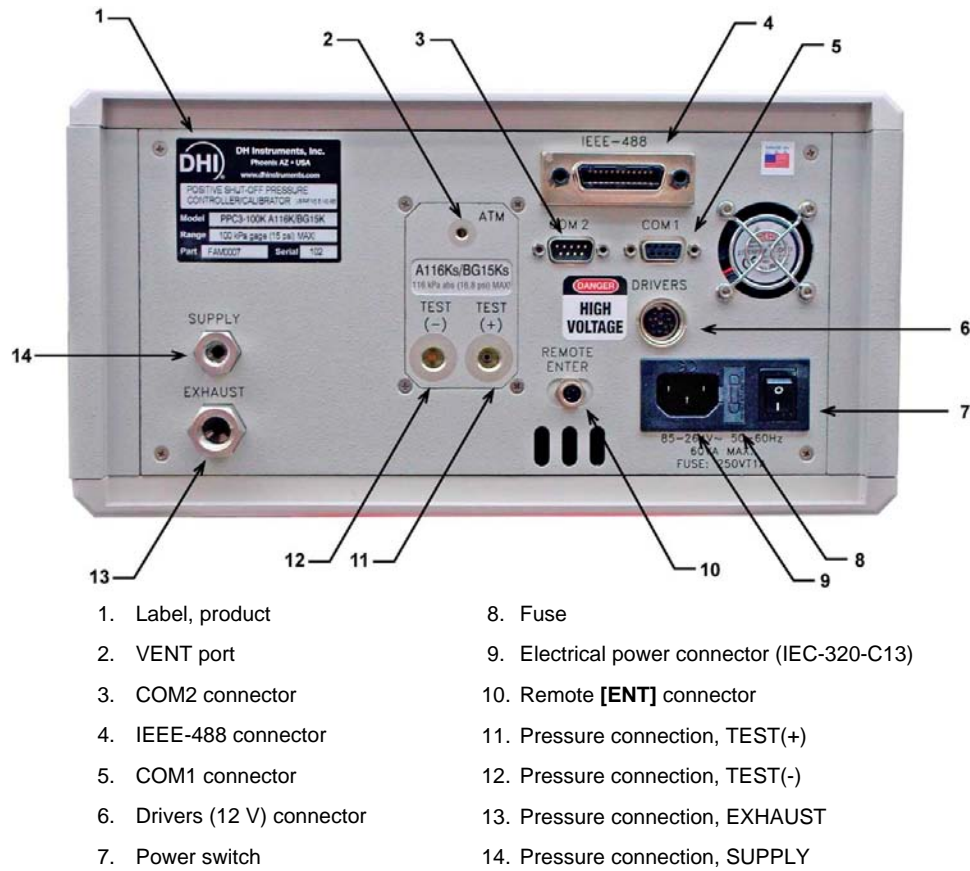


Figure 22. PPC3 rear panel

## 2.2.4 RPM4 A116K REFERENCE PRESSURE MONITOR

The ADCS-601-AF system includes an RPM4 Reference Pressure Monitor that is installed in the Control Cabinet (see Section 2.1.2). The RPM4 is used as a precise pressure comparator in the process of comparing the PG7601 and FPG8601 measurements when validating the FPG8601 (see Section 7.2.3).

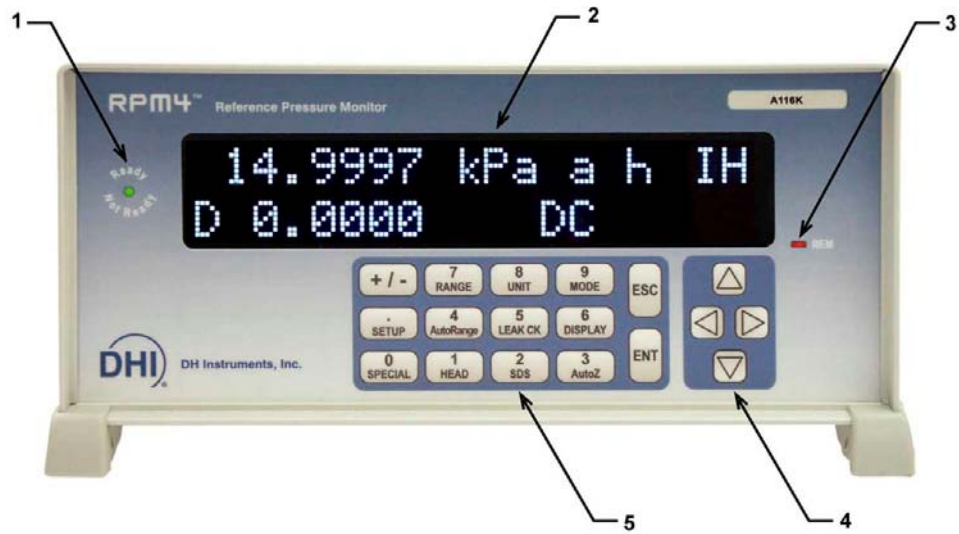
The RPM4 is an RPM4 A116Ks.



*The RPM4 pressure controller is a stand alone product for which a separate Operation and Maintenance manual is available with much more complete information than is included in this manual. A copy of the RPM4 manual is provided on the ADCS-601-AF Support CD and is available at [www.dhainstruments.com](http://www.dhainstruments.com).*

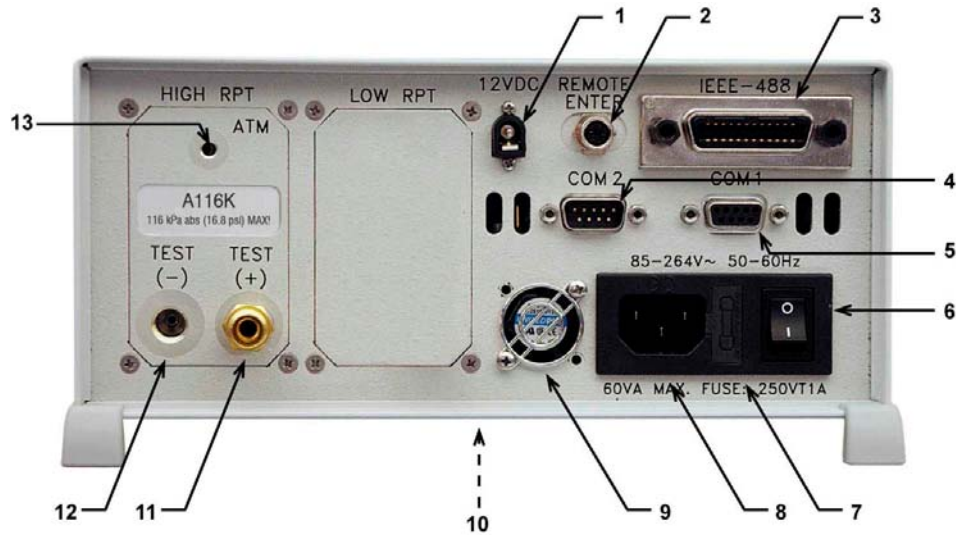
The RPM4 Reference Pressure Monitor includes a very high precision pressure transducer (Q-RPT) and the necessary hardware to connect the transducer to the ADCS-601-AF **TEST (+)** port when it is needed or isolate and vent it when it is not.

The RPM4 front panel provides a local user interface and display for the RPM4 Reference Pressure Monitor. Local commands to RPM4 are not used in normal ADCS-601-AF operation. See the RPM4 Operation and Maintenance manual for details on local operation of RPM4.



- |                              |                          |
|------------------------------|--------------------------|
| 1. Ready/Not Ready indicator | 4. Cursor control keys   |
| 2. Display                   | 5. Multi-function keypad |
| 3. Remote activity indicator |                          |

Figure 23. RPM4 front panel



- |                                  |   |
|----------------------------------|---|
| 1. 12VDC power supply connection | 8. Electrical power connector (IEC-320-C13) |
| 2. Remote [ENT] connector        | 9. Fan                                      |
| 3. IEEE-488 connector            | 10. Product label (bottom of case)          |
| 4. COM2 connector                | 11. TEST(+) pressure port                   |
| 5. COM1 connector                | 12. TEST(-) pressure port                   |
| 6. Power switch                  | 13. ATM pressure port                       |
| 7. Fuse                          |   |

Figure 24. RPM4 rear panel

## 2.3 VACUUM PUMPS

---



The ADCS-601-AF vacuum pumps are stand alone products for which separate Operation and Maintenance manuals are available with much more complete information than is included in this manual. A copy of the manual is provided on the ADCS-601-AF Support CD.

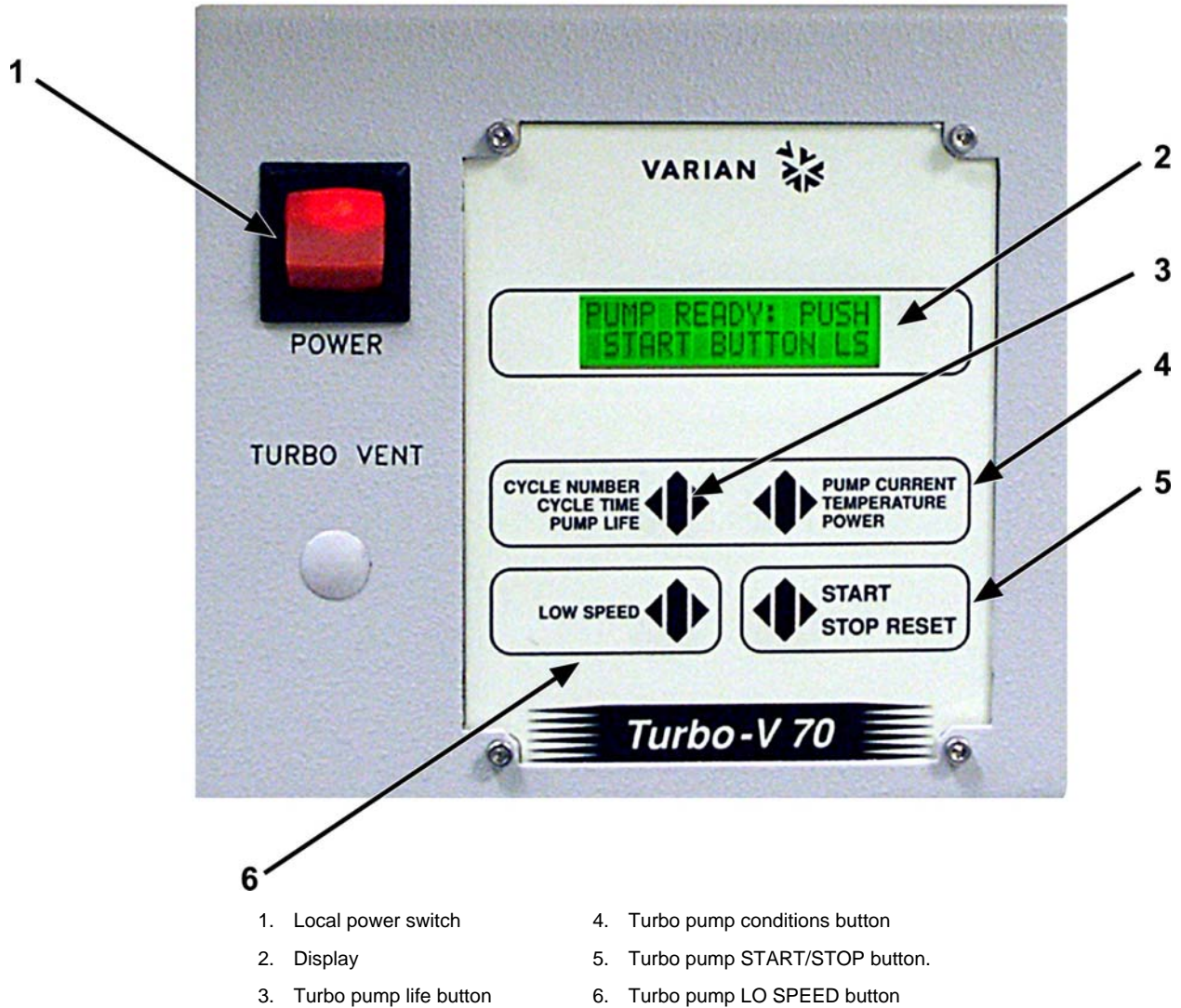
---

There are two vacuum sources in the ADCS-601-AF system.

- **Utility vacuum source:** The utility vacuum source provides vacuum to the pressure controllers so that they can control pressure under atmospheric pressure. The utility vacuum source is a dry, scroll pump that is normally located under the Reference Bench and has single connection to the Control Cabinet rear panel.
- **Reference vacuum source:** The reference vacuum source provides vacuum to the reference circuit of the PG7601 and FPG8601 pressure standards for operation in absolute mode. The reference vacuum source consists of a roughing pump and a turbo molecular pump. The roughing pump is a dry, scroll pump located under the Reference Bench. The turbo molecular pump is mounted to the bottom surface of the Reference Bench and includes a Controller mounted in a bracket under the Reference Bench.

See the original manufacturer Operation and Maintenance Manuals for additional information on the turbo molecular pump and turbo pump controller.





**Figure 25.** Turbo pump local interface panel (local control not used in regular ADCS-601-AF operation)





## 3. INSTALLATION

### 3.1 UNPACKING AND INSPECTION

Check that all items included in the ADCS-601-AF system are present and have NO visible signs of damage. A parts list of the major components supplied and how they are packed is provided in Table 1. Unpack and inspect the items following the instructions in Sections 3.1.1 to 3.1.12 and detailed parts list Table 1 to Table 10.

**Table 1.** ADCS-601-AF packing list

COMPONENT	SHIPPED IN	SECTION	DETAIL TABLE
Control Cabinet	wood crate	3.1.1	N/A
Reference Bench	wood crate	3.1.2	Table 2
ADCS-601-AF interconnections kit	corrugated container in Reference Bench wood crate	3.1.2	Table 3
ADCS-601-AF accessories kit	corrugated container in Reference Bench wood crate	3.1.2	Table 4
Reference vacuum CDG assembly for PG7601	corrugated container in Reference Bench wood crate	3.1.2	N/A
PG7601 Platform, PG7000 Terminal and accessories	molded transit case in corrugated outer carton	3.1.3	Table 5
PG7601 bell jar	double corrugated container	3.1.3	N/A
PG7601 piston-cylinder module and accessories (PC-7100/7600-10, TC)	corrugated container with foam insert , PVC bullet case	3.1.4	Table 6
PG7601 mass set (MS-AMH-38)	(2) molded transit cases in corrugated outer carton	3.1.5	Table 7
PG7601 automated mass handler (AMH-38)	corrugated container with foam inserts	3.1.6	Table 8
FPG8601 Platform, FPG8000 Terminal, piston-cylinder and accessories	molded transit case in corrugated outer carton	3.1.7	Table 9
FPG piston insertion tool	corrugated container in Reference Bench wood crate	3.1.2	N/A
FPG8601 mass set (MS-FPG-2)	molded transit case in corrugated outer carton	3.1.8	Table 10
(2) scroll vacuum pumps	corrugated containers with inserts in Reference Bench wood crate	3.1.2	N/A
Turbo molecular vacuum pump	corrugated container with inserts in Reference Bench wood crate	3.1.2	N/A
System controller (personal computer with display, keypad and pointing device)	(2) corrugated containers	3.1.11	N/A
System controller stand	corrugated container	3.1.12	N/A

### 3.1.1 ADCS CONTROL CABINET



The ADCS Control Cabinet weighs more than 100 kg (220 lb.). Do not attempt to remove it from the crate with less than two personnel qualified to handle heavy items.

The Control Cabinet (p/n 402198) is shipped in a large, wooden crate.

**To unpack:** Remove the top and at least two sides of the crate. Remove the packing bag from the cabinet. Lift and roll the cabinet out of the crate. This requires more than one person.

There are no accessories or items other than the Control Cabinet itself packed in the Control Cabinet crate.

### 3.1.2 ADCS REFERENCE BENCH AND ACCESSORIES

The Reference Bench is shipped assembled in a wooden crate. Tubing and accessories, a power strip and the vacuum turbo pump controller are mounted on the bench.

Also packed in the Reference Bench wooden crate are:

- ADCS interconnections kit in a corrugated container
- PG7601 reference vacuum CDG assembly in a corrugated container
- ADCS accessories kit in plastic bags
- FPG8601 piston insertion tool in a corrugated container
- (2) scroll vacuum pumps
- turbo molecular pump

**To unpack:** Remove top and at least two sides from the wood crate. Remove corrugated containers from under the bench taking care not to damage the vacuum pump controller and bracket mounted on the front of the bench. Remove the bench from the pallet.

Table 2 to Table 4 detail all items included with the Reference Bench and packed in the reference bench wooden crate.

**Table 2.** Reference Bench parts list

DESCRIPTION		PART # 402211
1 ea.	Reference bench with wood top (145 cm H x 122 cm W x 76 cm D (57 in. x 48 in. x 30 in.))	402210
1 ea.	Pneumatic interconnections and switching box (mounted on top of bench)	402214
1 ea.	TEST port bracket (mounted on top of bench)	402230
1 set.	Interconnecting tubing (mounted on top of bench)	in 402230, 402214
1 ea.	Turbo pump controller in bracket with power cord installed (mounted on bench)	402212
1 ea.	Power strip (mounted under bench)	in 402210

**Table 3.** Interconnections kit parts list

DESCRIPTION		PART # 402213
1 ea.	Tube, turbo pump vent (1/8 in. PFA)	402237
1 ea.	Tube assembly, interconnections box to FPG TEST (1/4 in. s.s. with 1/4 in. Swage x KF16 adaptor) (not in corrugated container, secured to top of bench)	402234
1 ea.	Tube, interconnections box to FPG CONTROL (1/4 in. s.s.) (not in corrugated container, secured to top of bench)	402235
1 ea.	Tube assembly, turbo pump to FPG VACUUM port (1/4 in. PFA. with 1/4 in. Swage x KF16 adaptor)	402236
1 ea.	Tube assembly, utility vacuum pump to Control Cabinet (3/8 in. PFA with 3/8 in. Swage x KF25 adaptor)	402238
1 ea.	Adapter, 3/8 in. Swage x 1/4 in. NPT M	101806
1 ea.	Adapter, 1/8 in. Swage x 10-32 O-seal	124436
2 ea.	Mounting bracket (main vertical vacuum tube)	123911
2 ea.	Screw and washer, M4, vacuum tube mounting bracket collar	101016-Z, 100918-Z
4 ea.	Screw and washer, 1/4-20., vacuum tube mounting bracket to bench	103846, 103435-Z, 102620-Z
4 ea.	Centering ring, KF16	101544
4 ea.	Clamp, KF16	102975
1 ea.	Tee, KF16	103696
1 ea.	Adaptor, KF25 x KF16	103237
5 ea.	Centering ring, KF25	101542
5 ea.	Clamp, KF25	102121
1 ea.	Hose, KF25 with flanges (PVC)	103720
3 ea.	Centering ring, KF40	103245
1 ea.	Screen, with KF40 centering ring	103633
4 ea.	Clamp, KF40	103246
1 ea.	Blank-off cap, KF40	103310
1 ea.	Cross, KF40	103649
1 ea.	Nipple, KF40	103651
1 ea.	Adaptor, KF40 x KF25 (bellows)	124098
1 ea.	Plug, DH200 M	100279
1 ea.	Adaptor, 1/4 in. Swage x 1/8 in. NPT M	102033
2 ea.	Adaptor, 1/8 in. Swage x 1/8 in. Legris	103425

**Table 4.** ADCS accessory kit parts list

DESCRIPTION		PART # 402224
4 ea.	Power cord (14 AWG,15 Amp) (AC1, AC2, AC3, turbo pump controller bracket)	103690
3 ea.	Fuse, 250VT 10A	103697
2 ea.	Quick connect stem, 1/8 in. NPT F	102116
2 ea.	Quick connect stem, 1/4 in. NPT F	102117
2 ea.	Quick connect stem, AN4 M	102115
1 ea.	Adaptor, KF40 x KF16	103650
1 ea.	ADCS-601-AF Operation and Maintenance Manual (hard copy)	550140

DESCRIPTION		PART # 402224
9 ea.	Calibration report: - PG7601 Platform - PG7601 10 kPa/kg piston-cylinder module - PG7601 AMH mass set - PG7601 reference vacuum CDG - FPG8601 platform with FPG8601 piston-cylinder - FPG8601 reference vacuum CDG - FPG8601 2 kg mass set - RPM4 A116Ks - PPC3-100K A116Ks/BG15Ks	550100
1 ea.	ADCS-601-AF Test Report	550141
1 ea.	ADCS-601-AF Support CD	402215
1 ea.	DHI General Accessory CD	102987

### 3.1.3 PG7601 PLATFORM AND BELL JAR

The PG7601 Platform is shipped in a molded transit case. The PG7601 Platform accessories are also included in the case. The PG7601 bell jar is packed in a separate double corrugated container.

**To unpack proceed as follows:**

- ❶ Open the PG7601 shipping and storage case.
- ❷ Remove the PG Terminal and accessories from the upper packing insert. Inspect and inventory the accessories (see Table 5).
- ❸ Remove the upper packing insert.
- ❹ Carefully lift the PG7601 Platform from its position in the lower packing insert. Note the orientation so that the same orientation is used when PG7601 is repacked.
- ❺ Reinstall the upper packing insert into the shipping and storage case and store in a safe place.

**Table 5.** PG7601 Platform parts list

DESCRIPTION		PART #
1 ea.	PG7601 platform including:	402216
1 ea.	Bell jar and seal (in separate double corrugated container)	122106 and 101546
1 ea.	PG7000 Terminal	401284
1 ea.	Power cord, 7.5 ft	100770
1 ea.	Cable, PG Terminal to Platform	102227
1 ea.	Molded transit case (in which the Platform is shipped)	122576
<b>Accessory kit including:</b>		<b>402217</b>
2 ea.	O-ring, Buna 2-242	101976
1 ea.	Tool, 3 mm hex wrench (with T handle)	103473
1 ea.	Cable, null modem	402114
1 ea.	Allen wrench, 5 mm	102262
1 ea.	Spanner wrench (metrological)	122568
1 ea.	Krytox® GPL205/6 .5 oz.	102496
1 ea.	Gift kit with gloves	400511

### 3.1.4 PG7601 PISTON-CYLINDER MODULE (PC-7100/7600-10,TC)

The piston-cylinder module is shipped in a PVC bullet case packed in a corrugated container with custom foam inserts. The piston-cylinder module accessories are also in the corrugated container.

Open the corrugated container and remove the piston-cylinder module and accessories.

The bullet case screws open by turning the lid counterclockwise.

Table 6 details all items included with the PG7601 piston-cylinder module.

**Table 6.** PC-7100/7600-10, TC piston-cylinder module parts list

DESCRIPTION		PART # 401562
1 ea.	PC-7100/7600-10, TC piston-cylinder module	401418
1 ea.	PVC bullet case	401642
<b>Accessory kit including:</b>		<b>401243</b>
1 ea.	O-ring, Viton 2-222	101918
1 ea.	O-ring, Viton 2-130	102380
1 ea.	Piston insertion tool	122186

### 3.1.5 PG7601 MASS SET (MS-AMH-38)



*The stability over time of PG7601 pressure measurements is a function of the stability of the masses loaded on the piston. Precautions should be taken in handling the masses to minimize influences that may change their mass. This includes always wearing protective gloves when handling the masses to avoid contaminating them with body oils and perspiration. Protective gloves are provided in the accessory kit of the PG7601 Platform.*

The PG7601 mass set is shipped in (2) molded transit cases. The PG7601 masses should be removed from their shipping cases and inventoried when actually setting up the PG7601 system.

**To unpack:** Do not unpack the masses until you are ready to install them on the PG7601 Platform (see Section 3.3.9.2). Wear protective gloves when handling the masses. Carefully remove each mass from the transit case and take it out of its sealed plastic bag.

Table 7 details all items included with the MS-AMH-38 mass set.

**Table 7.** MS-AMH-38 mass set parts list

DESCRIPTION		PART # 402219
1 ea.	Molded transit case	402096
1 ea.	Molded transit case	123949
<b>38 kg mass set including:</b>		<b>402233</b>
1 ea.	Mass loading bell	402090
1 ea.	Binary mass carrier	123855
1 ea.	Mass lifting shaft/trim mass tray	402113
1 ea.	0.1 kg tubular mass	123850-01
1 ea.	0.2 kg tubular mass	123850-02
1 ea.	0.4 kg tubular mass	123850-03
1 ea.	0.8 kg tubular mass	123850-04
1 ea.	1.6 kg tubular mass	123850-05
1 ea.	3.2 kg tubular mass	123850-07
5 ea.	6.4 kg mass disc	123851

### 3.1.6 PG7601 AUTOMATED MASS HANDLER (AMH-38)

The AMH-38 automated mass handler is delivered in a corrugated container with foam inserts. The AMH-38 accessories are included in the same corrugated container.

Remove all parts from the shipping container. Be sure not to lose or discard the accessories.

Table 8 details all items included with the AMH-38 automated mass handler.

**Table 8.** AHM-38 automated mass handler parts list

DESCRIPTION		PART #
1 ea.	AHM-38 Automated Mass Handler	402100
<b>Accessory kit including:</b>		<b>402218</b>
1 ea.	15 VDC power supply	103986
1 ea.	Power cord	100770
4 ea.	Cable tie, hook and loop	103485
1 ea.	O-ring, Viton, 2-273	103493

### 3.1.7 FPG8601 PLATFORM, PISTON-CYLINDER AND ACCESSORIES

The FPG8601 Platform is shipped in a molded transit case. The FPG8601 Platform accessories are also included in the case.

The FPG8601 piston insertion tool is packed in a separate corrugated container.

**To unpack proceed as follows:**

- ❶ Open the FPG8601 shipping and storage case. The top of the case removes completely.
- ❷ Remove the FPG Terminal, piston-cylinder, manifold, vacuum reference CDG assembly and accessories from the upper packing insert. Inspect and inventory (see Table 9).
- ❸ Remove the upper packing insert.
- ❹ Carefully lift the FPG8601 Platform from its position in the lower packing insert.
- ❺ Reinstall the upper packing insert into the shipping and storage case and store in a safe place.

Table 9 details all items included with the FPG8601 Platform.

**Table 9.** FPG8601 Platform parts list

DESCRIPTION		PART #
1 ea.	FPG8601 Platform including:	402207
1 ea.	FPG8000 Terminal	401671
1 ea.	Cable, FPG Terminal to Platform	102227
1 ea.	Power cord	100770
1 ea.	Bypass manifold	402209
2 ea.	Piston-cylinder O-ring carriers (taped to front of FPG Platform)	in 402207
1 ea.	Valve, FPG CONTROL, tube pneumatically actuated (Valve 11)	in 402209
1 ea.	CDG, reference vacuum assembly with valve	402227
1 ea.	Cable, CDG connection	402228
1 ea.	Piston-cylinder assembly in PVC bullet case	401662
1 ea.	Molded transit case (in which the Platform is shipped)	123346

Accessory/interconnect kit including:		402226
4 ea.	KF16 clamps	102975
DESCRIPTION		PART #
4 ea.	KF16 centering rings	101544
1 ea.	Blank-off cap, KF16	103238
1 ea.	O-ring, silicone, 2-128	103621
1 ea.	O-ring, Vitonr brown, 2-128	103692
1 ea.	O-ring, silicone, 2-151	103004
1 ea.	Bottle, 125 ml, distilled water	402229
1 ea.	Piston insertion tool (in separate corrugated carton in Reference Bench wood crate)	402231

### 3.1.8 FPG8601 MASS SET (MS-8601-2)



Precautions should be taken in handling the masses to minimize influences that may change their mass. This includes always wearing protective gloves when handling the masses to avoid contaminating them with body oils and perspiration. Protective gloves are provided in the accessory kit of the PG7601 Platform.

The FPG8601 mass set is shipped in a black, molded plastic case in a corrugated liner.

The FPG8601 mass set is not used in day to day ADCS-601-AF operation (see Section 7.2.5).

Table 10 details all items included with the FPG8601 mass set.

**Table 10.** MS-8601-2 mass set parts list

DESCRIPTION		PART # 401672
1 ea.	CLB hanger	401789
1 ea.	Molded case with insert	402072
3 ea.	0.5 kg mass	123500
2 ea.	0.2 kg mass	123498
1 ea.	0.1 kg mass	123496

### 3.1.9 SCROLL VACUUM PUMPS

Two identical scroll vacuum pumps are included in the ADCS-601-AF system. One is the roughing pump for the reference vacuum turbo pump. The other is the utility vacuum pump.

The pumps are delivered with their power cord in corrugated containers with foam inserts.

The part number of the scroll pump is 103630 or 103717.

### 3.1.10 TURBO MOLECULAR VACUUM PUMP

The turbo molecular vacuum pump is delivered in a corrugated container with foam inserts.

The part number of the turbo molecular pump is 103631

### 3.1.11 SYSTEM CONTROLLER

The system controller consists of a personal computer, flat panel display, keyboard and pointing device ("mouse"). These are packed in (2) to (4) corrugated containers, depending on configuration.

The system controller is delivered with all necessary ADCS-601-AF system software pre-loaded including:

- ADCS Tools-AF™
- FPG Tools™
- COMPASS for Pressure™
- USB hub driver

The part number of the system controller is 103388.

### 3.1.12 SYSTEM CONTROLLER STAND

The system controller stand is packed in a corrugated container with assembly instructions. For most users, the stand is a temporary solution for mounting the system controller at the time of initial system installation and start up.

The part number of the system controller stand is 103695.

## 3.2 SITE REQUIREMENTS

The environment required to operate an ADCS-601-AF Air Data Calibration Standard within its estimated measurement uncertainty limits is generally that of a high level, physical metrology laboratory.

When selecting and preparing a site to set up the ADCS-601-AF system, the following should be considered:

- **Ambient conditions:** To achieve optimum metrological performance, ambient conditions should be controlled and maintained within the following limits:
  - **Temperature:** 19 to 23 °C, minimize rate of change of temperature.
  - **Relative Humidity:** 10 to 60 %RH (non-condensing).
  - **Ambient Pressure:** Minimize external influences that will cause barometric instability.
  - **Air Currents:** Do not install the ADCS-601-AF Reference Bench under a source of vertical air currents such as an overhead air conditioning or heating ducts. These can exaggerate rate of change of ambient temperature.
  - **Vibration:** Minimize local vibration. Excessive vibration will reduce the stability of the pressures defined by PG7601 and the FPG8601 (vibration affects the floating piston).
- **Overall footprint:** The ADCS-601-AF Control Cabinet and Reference Bench must be disposed as shown in Figure 1. Select a location where adequate space is available, also consider the location of the system controller (PC) and connection of a device under test (DUT). See Figure 26 for typical ADCS-601-AF system layout at site of use.
- **Access to rear of Control Cabinet and Reference Bench:** To perform maintenance functions and troubleshoot the ADCS-601-AF system, it is necessary to have access to the rear of the Control Cabinet and Reference Bench. Be sure the ADCS-601-AF is installed so that 360 degree access to areas of the system is available.
- **Electrical power supply:** Plan the supply of electrical power to the Control Cabinet. See Section 1.1.1 for electrical power requirements. Note that the vacuum pumps draw a high amount of power, particularly when starting up.
- **Pressure supplies:** Plan the pneumatic pressure supplies to the rear panel of the Control Cabinet. Two separate supplies are required (see Section 1.1.1). The **Test Gas Supply** must be very clean and dry. This gas supplies the PG and FPG piston-cylinders. Cleaner gas will reduce maintenance by reducing the necessary piston-cylinder cleaning frequency.
- **Bell jar and AMH placement:** Plan a location for the PG7601 bell jar and automated mass handler when they are removed from the platform.



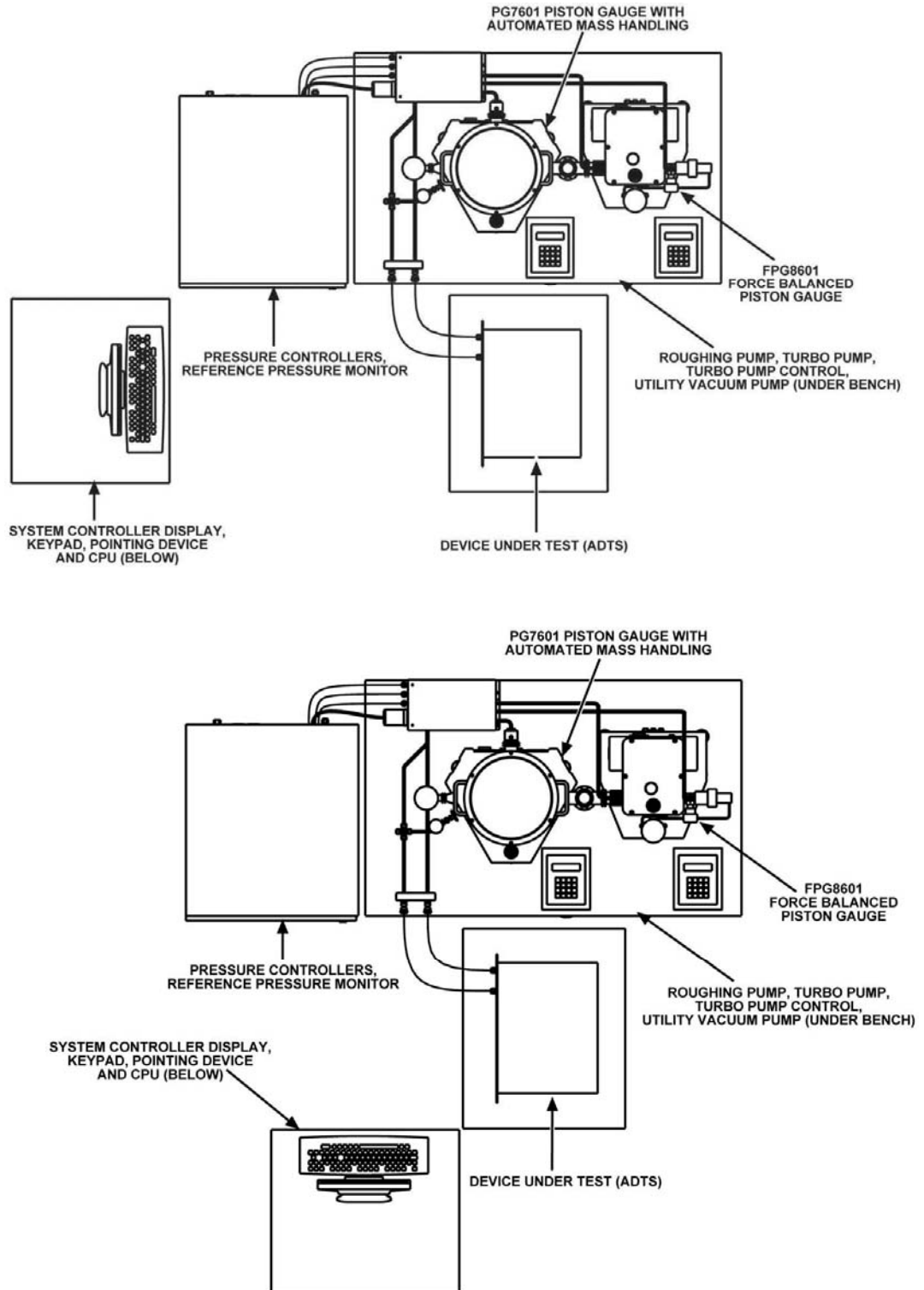


Figure 26. Typical layout of overall ADCS-601-AF system at site of use

## 3.3 SETUP

---



Before setting up the ADCS-601-AF system, see Section 3.2 for information on site requirements.

---



ADCS-601-AF is a complex system made up of several sub-systems. Setting up and verifying the complete system is an extensive, step by step, process in which the sequence of operations is important. Always follow the instructions in Sections 3.3.1 to 3.4.6 in sequential order when setting up and verifying the system. Allow a minimum of three hours to complete the process.

---

To set up the ADCS-601-AF system, first unpack it following the instructions in Section 3.1. Then follow the set up instructions in Sections 3.3.1 to 3.3.13 sequentially. Once the system is set up, power it up, initialize it and verify it following the instructions in Section 3.4.

Note all fittings, adaptors and parts mentioned in the setup instructions are included with the ADCS-601-AF unless specifically stated otherwise. See the parts lists in Section 3.1 to locate all parts.

---



When assembling, use Teflon® tape or other appropriate thread sealer on all NPT thread fittings.

---

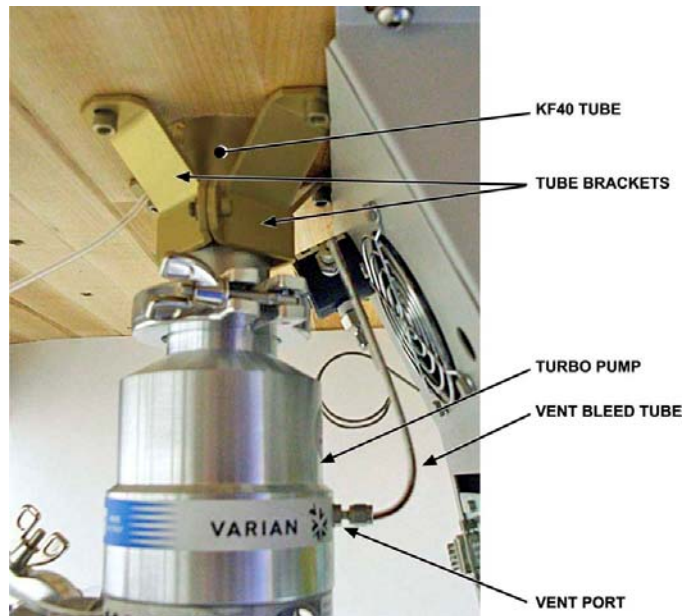
### 3.3.1 POSITION THE REFERENCE BENCH

Refer to the Site Requirements section of this manual and then position the bench and table where you want them (See Section 3.2). Consider positioning of everything including gas supplies, pumps, access to rear of system, DUT and computer.

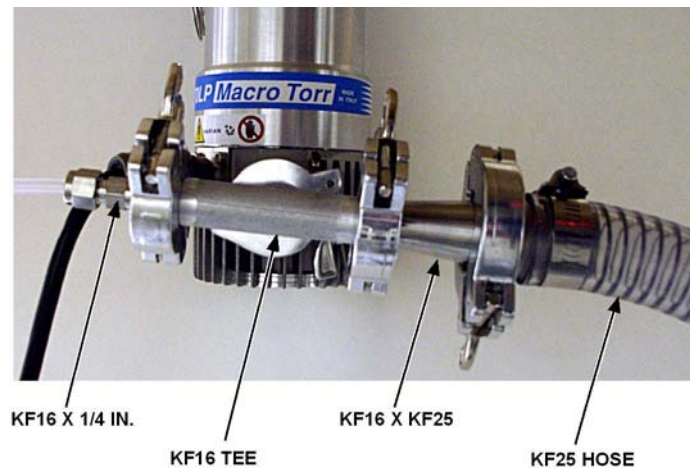
Move the Control Cabinet out of the way until it is needed.

### 3.3.2 INSTALL REFERENCE TURBO VACUUM AND ROUGHING PUMPS

- ❶ Attach the turbo pump to the vacuum tube that extends down through the bench using a KF40 flange and a the KF40 centering ring with a screen. Orient the pump so that its lateral KF16 flange is facing towards the rear of the bench.
- ❷ Attach turbo pump controller cable (on turbo pump controller) to the turbo pump.
- ❸ Install PFA vent bleed tube between the adaptor and the valve attached to the turbo pump controller bracket.



- ❹ Install a KF16 tee onto the turbo pump KF16 fitting. Orient the tee so that the common port is connected to the turbo pump and the legs are perpendicular to the pump body.
- ❺ Install a KF16 x KF25 adaptor on the right side (looking from rear) of the KF16 vacuum tee.
- ❻ Position vacuum roughing pump under the bench (the two scroll vacuum pumps provided are identical, so either one may be used here).



- ❼ Connect turbo pump KF25 connection to roughing pump using KF25 plastic hose.

### 3.3.3 POSITION THE PG7601 AND FPG8601 PLATFORMS ON THE REFERENCE BENCH

Place the PG7601 and FPG8601 Platforms and their Terminals in their approximate positions on the bench (see Figure 7).

### 3.3.4 PREPARE FPG8601

❶ Attach the FPG manifold to the KF16 FPG8601 high control port. Do not make the low control port connection. Connect the 1/8 in. plastic tube included with the manifold between valve 10 on the manifold and the **V10** port on the FPG platform.

❷ Attach FPG valve 11 to the 1/4 Swage fitting on the top of the FPG manifold. Orient the valve so that the flow arrow points away from the manifold (up). Connect the 1/8 in. plastic tube included with valve 11 between valve 11 and the **V11** port on the FPG platform.

❸ Install a KF16 blank-off cap on the FPG8601 low test port.

❹ Install 1/8 in. NPT M x 1/8 in. Legris adaptors into the **DRIVE IN** and **LUBRICATION SUPPLY** ports on the rear of the FPG8601 Platform (see Figure 20).

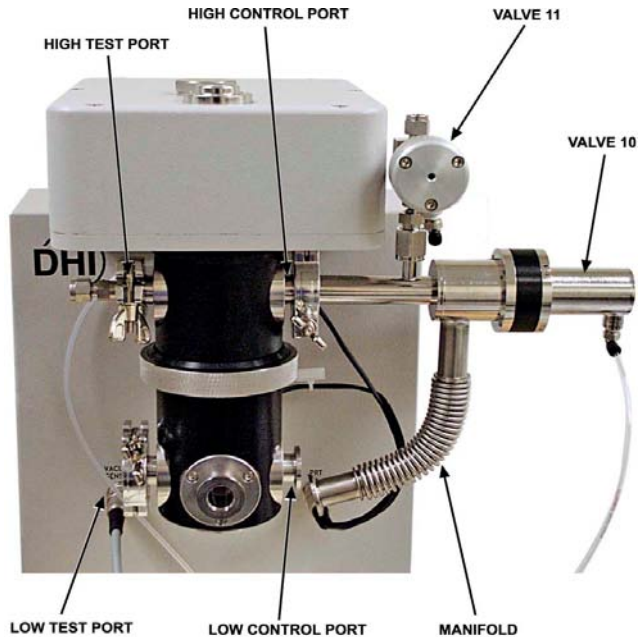
❺ Install a 1/8 NPT M x 1/4 in. Swage adaptor into the **VACUUM** port on the rear of the FPG8601 Platform (see Figure 20).

❻ Connect the FPG vacuum tube assembly (1/4 in. PFA with 1/4 in. Swage x KF16 adaptor installed) between the FPG **VACUUM** port and the KF16 tee previously installed on the turbo pump under the bench.

❼ Connect the FPG8000 Terminal to the rear of the FPG8601 platform rear with the 25 pin cable.

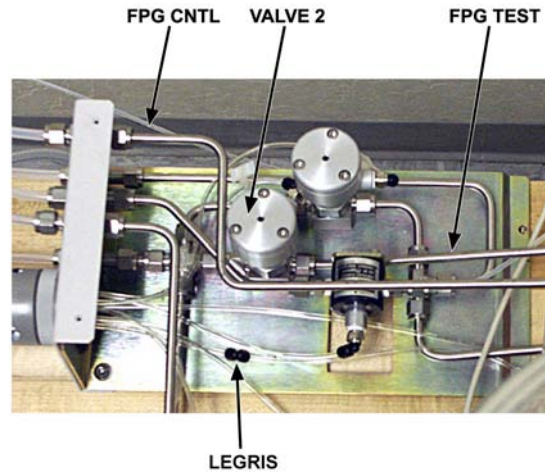
❽ Connect the FPG8601 power cord (16 AWG) from the FPG8000 Terminal to the power strip underneath the bench. Do not power up the FPG8601.

❾ Fill the FPG8601 bubbler bowl with distilled water (see Section 6.2).



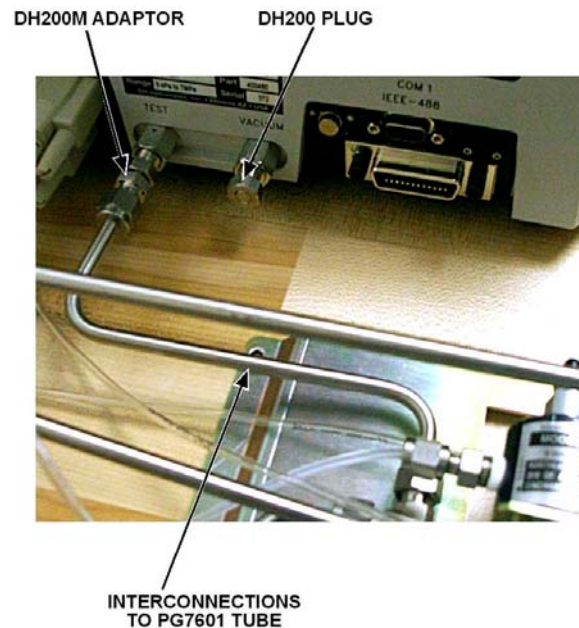
### 3.3.5 MAKE PNEUMATIC INTERCONNECTIONS ON THE REFERENCE BENCH

- ❶ Remove and set aside the cover from the Reference Bench pneumatic interconnections box by removing the four screws that hold it (see Figure 7).
- ❷ Unwind the (4) 1/8 in. pneumatic lines coming out of the interconnections box.
- ❸ Connect the 1/4 in. stainless steel tube labeled **FPG CNTL** to the inside of the **FPG CONTROL** port on the interconnections box bulkhead. Before tightening, orient the tube so that the connection to the top port of valve 11 on the FPG8601 can be made (see Section 3.3.4). Make the connection to valve 11. Tighten both fittings.



- ❹ Connect the 1/4 in. stainless steel tube labeled **FPG TEST** to the 1/4 in. Swage open port on valve 2 in the interconnections box. Before tightening, orient the tube so that the KF16 connection to the FPG8601 high test port can be made (see Section 3.3.4). Make the connection to the FPG high test port. Tighten the 1/4 in. Swage connection.

- ❺ There is a 1/4 in. stainless steel tube with a 1/4 in. Swage by DH200 M adaptor installed coming out of the interconnections box. Connect the DH200 M end of the adaptor to the **TEST** port on the rear of the PG7601 platform. The gland and collar for the DH200M adaptor are delivered in the **TEST** port. Be sure both the Swage and swage DH200 M nuts are tight.



- ❻ Install a DH200 stainless steel plug in the **VACUUM** port on the rear of the PG7601 platform. The gland for the DH200M plug is delivered in the **TEST** port. No collar is used with a plug.



- ⑦ Make the PG7601 platform lateral KF25 vacuum port connection to the Reference Bench tubing using a KF25 clamp and centering ring.
- ⑧ Ensure that the 1/8 in. pneumatic line labeled **4** is connected between the interconnections box and the valve labeled **V4** at the PG7601 lateral KF25 vacuum port.
- ⑨ Connect the 1/8 in. pneumatic line labeled **7** from the interconnections box to the **DRIVE IN** port on the rear of the FPG8601 platform.
- ⑩ Ensure that the 1/8 in. pneumatic line labeled **6** runs from the interconnections box down through the reference vacuum tube hole in the bench and connects to the valve labeled **V6** on the back of the turbo pump controller bracket.
- ⑪ Reinstall the Reference Bench pneumatic interconnections box cover that was removed in ①.



### 3.3.6 POSITION CONTROL CABINET AND MAKE PNEUMATIC, COMMUNICATIONS AND ELECTRICAL CONNECTIONS TO REFERENCE BENCH

- ① Position the Control Cabinet next to the Reference Bench (see Figure 26). Once the Cabinet is positioned, extend the feet under each corner of the cabinet to level the cabinet in a fixed position.
- ② Unwind the large bundle of pneumatic tubes and electrical connections that originate from the rear opening of the cabinet.
- ③ Connect the large, grey, (8) port connector from the Control Cabinet to the **VALVE CONTROL** connection on the Reference Bench interconnections box bulkhead.
- ④ Connect the 1/4 in. PFA tube labeled **MONITOR** to the **MONITOR** connection on the Reference Bench interconnections box bulkhead.
- ⑤ Connect the 1/4 in. PFA tube labeled **PG CNTL(+)** to the **PG CONTROL(+)** connection on the Reference Bench interconnections box bulkhead.
- ⑥ Connect the 1/4 in. PFA tube labeled **UTIL VAC** to the **UTILITY VACUUM** connection on the Reference Bench interconnections box bulkhead.
- ⑦ Connect the 1/4 in. PFA tube labeled **FPG CNTL(-)** to the **FPG CONTROL(-)** connection on the Reference Bench interconnections box bulkhead.
- ⑧ Connect the 1/4 in. PFA tube labeled **FPG CNTL(+)** to the **FPG CONTROL(+)** connection on the Reference Bench interconnections box bulkhead.
- ⑨ Connect the 1/8 in. PFA tube labeled **FPG LUB SUP** to the **LUBRICATION SUPPLY** port on the rear of the FPG8601 platform.
- ⑩ Connect the 9 pin D-sub cable labeled **PG COM1** to the **COM1** port on the rear of the PG7601 Platform.

- ① Connect the 9 pin D-sub cable labeled **PG COM2** to the **COM2** port on the rear of the PG7601 Platform.
- ② Connect the 9 pin D-sub cable labeled **PG COM3** to the **COM3** port on the rear of the PG7601 Platform.
- ③ Connect the 9 pin D-sub cable labeled **FPG COM1** to the **COM1** port on the rear of the FPG8601 Platform.
- ④ Connect a 14 AWG/20 A power cord from the rear of the turbo pump controller enclosure to the **AC2 REFERENCE ROUGHING PUMP CONTROLLER** socket on the rear of the Control Cabinet. **Do NOT** connect it to the **AC2 REFERENCE TURBO PUMP CONTROLLER** socket.
- ⑤ Connect the reference vacuum roughing pump cord to one of the two power sockets on the rear of the turbo pump controller enclosure.
- ⑥ Connect the power cord from the power strip under the Reference Bench to the **AC1 BENCH INSTRUMENTS** socket on the rear of the Control Cabinet.
- ⑦ Connect 14 AWG/20 A power cords from the **AC1**, **AC2** and **AC3** IEC connectors on the rear of the Control Cabinet to a 110 V, 60 Hz power supply.
- ⑧ Power up the Control Cabinet by operating the **REFERENCE BENCH (AC1)** power switch on the front, top, left of the cabinet. The two PPC3 pressure controllers and the RPM4 reference pressure monitor will power up and go to their main run screens. **Do NOT** operate either of the **PUMP (AC2, AC3)** power switches.

### 3.3.7 CONNECT PRESSURE SUPPLIES TO CONTROL CABINET

- ① Connect a drive air supply to the **DRIVE AIR SUPPLY** port on the rear of the Control Cabinet. The fitting is a 1/4 in. NPT F. The connecting tube and adaptor are not supplied. See Section 1.1.1 for drive air supply requirements.
- ② Connect an instrument gas supply to the **TEST GAS SUPPLY** port on the rear of the Control Cabinet. The fitting is a 1/4 in. NPT F. The connecting tube and adaptor are not supplied. See Section 1.1.1 for test gas supply requirements.

### 3.3.8 APPLY SUPPLY PRESSURES AND CHECK GAS SUPPLY PANEL SETTINGS



*Once the TEST GAS SUPPLY has been applied, do not interrupt it without following the procedure described in Section 6.11.*

- ① Open the door on the front of a Control Cabinet to access the Control Panel. Key to the door lock is stored inside the door. Verify that the **AMH DRIVE** and **FPG LUBRICATION** regulators on the Control Panel are off (regulator set fully counter clockwise).
- ② Apply the supply pressure to the **SUPPLY** ports on the rear of the Control Cabinet (see Section 3.3.7, Steps 1, 2).
- ③ Leave the **AMH DRIVE** and **FPG LUBRICATION** regulators set to zero. Check and adjust the other Control Panel regulator settings as necessary. See Section 6.13 for definition of correct settings.

### 3.3.9 SET UP THE PG7601

#### 3.3.9.1 PREPARE THE PLATFORM AND INSTALL THE PISTON-CYLINDER MODULE

- ❶ Connect the PG7601 Terminal to the PG7601 platform rear with 25 pin cable.
- ❷ Connect the PG7601 power cord from the PG7000 Terminal to the power strip underneath the bench. **Do not power up the PG7601.**
- ❸ Remove the PG7000 Platform mounting post plug. Unscrew the ORANGE plastic mounting post plug that is installed in the PG7000 Platform mounting post. Rotate counterclockwise to remove.
- ❹ Remove the PC-7100/7600-10, TC piston-cylinder module from its bullet case. Open the bullet case by rotating its lid counterclockwise. Remove the piston-cylinder module from the bullet case base by unthreading it from the case. Hold the piston-cylinder module body by the knurled area and rotate it counterclockwise.
- ❺ Place the piston-cylinder module (thread down) into the PG7601 mounting post (see Figure 27). Rotate the piston-cylinder module clockwise until all threads are engaged and there is NO gap between the piston-cylinder module and the PG7601 mounting post. Slight resistance will be encountered in the second half of travel as the piston-cylinder module O-rings seat in the mounting post.

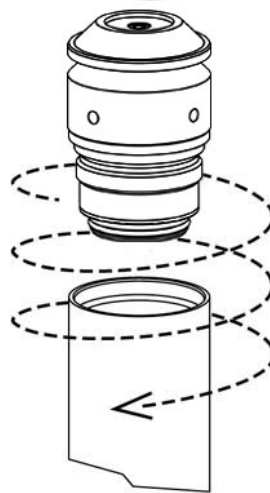


Figure 27. Piston-cylinder module installation

#### 3.3.9.2 INSTALL THE AMH-38 MASS SET



*The stability over time of PG7601 pressure measurements is a function of the stability of the masses loaded on the piston. Precautions should be taken in handling the masses to minimize influences that may change their mass. This includes always wearing protective gloves when handling the masses to avoid contaminating them with body oils and perspiration. Protective gloves are provided in the accessory kit of the PG7601 Platform.*

See Section 2.2.1.5 to identify the different elements of the 38 kg mass set.



- ❶ Open the mass set molded, transit cases and remove all the masses and mass set elements from their plastic bags.
- ❷ Place the pyramidal shaped binary mass carrier on top of the piston cap.
- ❸ Slip the mass loading bell over the binary mass carrier and slide it down until the inside top of the bell sits on the binary mass carrier.
- ❹ Install the main mass discs (6.4 kg each with AMH-38) onto the mass bell **starting with mass #1 and loading up in sequential order**. Mass #1 should be at the bottom of the stack and mass #5 at the top. The mass sequence numbers are laser marked on the top surface of each mass. Pass the mass disc over and down the mass loading bell and center it on the ledge at the bottom of the bell. Load the rest of the main masses, sequentially, onto the bottom mass.
- ❺ Install the binary mass tubes concentrically from the largest to smallest, outside to inside. The largest, long tubes slip down between the main mass stack and the bell and rest on the ledge at the bottom of the mass bell. The smaller masses load onto the pyramidal steps of the binary mass carrier.
- ❻ This phase of mass set installation is complete. The mass lifting shaft assembly is not yet installed. It will be installed after the AMH automated mass handler is installed over the masses on the platform (see Section 3.3.9.3).

### 3.3.9.3 INSTALL THE AMH-38 MASS HANDLER

- ❶ Place the AMH-38 mass handler on top of the Control Cabinet or at another convenient location near the PG7601 Platform.
- ❷ Connect the AMH-38 15V power supply to the rear of the AMH-38 and plug it into the power strip under the Reference Bench.
- ❸ Connect the 9 pin D-sub cable labeled **AMH COM1** to the **COM1** port on the rear of the AMH-38.
- ❹ Connect the 1/8 in. pneumatic line labeled **8 RED** from the Reference Bench interconnections box to the drive air port on the back of the AMH-38. The drive air port is the top port of the two quick connectors with a red band. Press the quick connect stem into the connector firmly until it clicks into place.
- ❺ Open the door on the front of a Control Cabinet to access the Control Panel. Set the **AMH DRIVE** regulator on the Control Panel as specified in Section 6.13.
- ❻ Insert the mass lifting shaft into the hole in the center of the AMH mass lifter and slide it down until the trim mass tray sits on the top of the lifter. This arrangement trips the AMH's internal proximity sensor allowing the AMH system to be operated off of the PG7000 Platform without an actual mass load.
- ❼ Set the COM1 and COM2 ports of the PPC3-700K pressure controller and the COM3 port of the PG7601 (see Section 3.4.2).
- ❽ Power up the PG7601 Platform using the power switch on the rear of the PG7000 Terminal. If the PG7601 is already powered up, use [**SPECIAL**], **<8AMH>**, **<2control>**, **<3loadall>** from the PG7000 Terminal front panel. The AMH-38 trim mass tray should rise approximately 2.5 cm (1 in.) above the top of the lifter; followed by the sound of the main mass selection columns rotating. Then the trim mass tray should be lowered back down. The steps of this procedure are commented on the PG Terminal display as they execute. See Section 6.5 for additional information on installing and removing AMH-38 from the PG7601 Platform.

- ⑨ Visually inspect the condition of the AMH-38 mass handler by carefully tipping it to look inside. The main mass selection columns should have all their flat surfaces (no ledges) oriented towards the center and all binary mass selection pins should be retracted. If these conditions are present the AMH-38 is ready to install on the PG7601 Platform.
- ⑩ Install the AMH-38 mass handler onto the PG7601 Platform (see Section 6.5.1, Figure 50). Verify that the O-ring is installed on the bottom circumference of the AMH-38 vacuum chamber. Using the handles on the side of the AMH-38 vacuum chamber, lift the AMH-38 above the PG7601 platform and masses. Center it over the mass load and gently lower it down until the bottom circumference of the AMH-38 vacuum chamber reaches the PG7601 vacuum plate. Check that the vacuum chamber is well aligned on the vacuum plate.
- ⑪ Connect the 1/8 in. PFA tube labeled **5** (with blue band on quick connect stem) from the Reference Bench interconnections box to the vacuum port on the back of the AMH-38. The vacuum port is the bottom port of the two quick connectors with a blue band. Press the quick connect stem into the connector firmly until it clicks into place.



*It is imperative that the mass loading shaft be fully threaded into the binary mass tray. Be sure to use the T handled 3 mm allen wrench to tighten the shaft to the end of the threads applying sufficient torque to cause the mass load to rotate. Failure to fully screw in the shaft will cause misalignment between the mass handler and the mass load that may cause damage to the AMH-38 mass handler when operated.*

---

- ⑫ Install the AMH-38 mass lifting shaft. Slip the threaded end of the shaft down through hole in the center of the mass lifter (see Section 6.5.1, Figure 50). Thread the shaft into the binary mass carrier by holding and rotating the trim mass tray. NOTE THAT SHAFT HAS A LEFT HAND THREAD SO IT MUST BE ROTATED COUNTER-CLOCKWISE TO TIGHTEN IT. Use the T handled, 3 mm allen wrench supplied in the AMH-38 accessories to tighten the assembly. Tighten until you feel the mass start to rotate.
- ⑬ Level the PG7601 Platform using its two leveling feet and the level mounted on the top of the AMH-38 mass handling system.

#### 3.3.9.4 INSTALL THE REFERENCE VACUUM CDG ASSEMBLY

---



*The PG7601 and FPG8601 reference vacuum CDGs are delivered with an isolation valve connected to them. This valve is normally closed and serves to maintain vacuum on the CDG at all times as exposing the CDG to atmospheric pressure will cause zero shifts. New CDGs are shipped with vacuum behind the isolation valve. Do not break the valve fittings or operate the valve without establishing vacuum first.*

---

- ① Connect the PG7601 reference vacuum CDG assembly (CDG, valve, KF16 x KF40 adaptor) to the KF40 port on the left (viewed from front) of the AMH-38 vacuum chamber. Use a KF40 centering ring and clamp. Install so that the CDG body is in the vertical position.
- ② Connect the 15 pin cable labeled **PG CDG** from the Control Cabinet to the top of the CDG.

- ⑤ Connect the 1/8 drive air tube labeled **3** from the Reference Bench interconnections box to the valve labeled **V3** on the PG7601 CDG assembly.

### 3.3.10 COMPLETE FPG8601 SETUP

#### 3.3.10.1 INSTALL THE PISTON-CYLINDER

The FPG8601 10 kPa/kg piston-cylinder is shipped in a PVC bullet case.



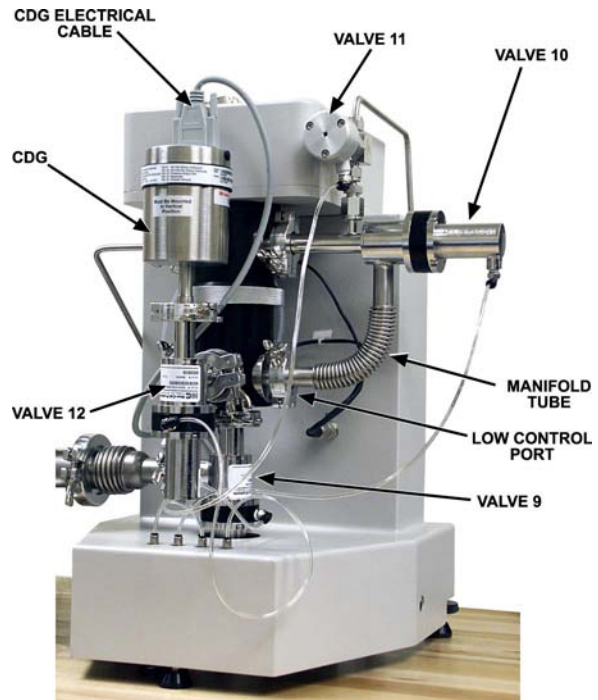
*NEVER touch the lapped surfaces (polished appearance) of the piston or cylinder with your bare hands. Body oils and acids can permanently etch the surfaces.*

- ① Open the piston-cylinder bullet case by rotating its lid counterclockwise (if necessary, remove the 2.5 mm countersunk screw on the lower (flat) section of the bullet case to vent the inside of the case).
- ② Remove the upper section of the bullet case.
- ③ Put on gloves to protect the piston-cylinder from contamination before handling it.
- ④ Cup the exposed piston-cylinder with one hand and turn the piston-cylinder lower section of the bullet case upside down supporting the piston-cylinder with the cupped hand.
- ⑤ Lift the lower section of the bullet case off of the piston-cylinder.
- ⑥ Place the piston-cylinder on to a stable soft surface (lint-free towels). Take care that the piston does not slide out of the cylinder.
- ⑦ Remove the FPG8601 lower mounting post. Loosen the nut at the center of mounting post while applying slight upward pressure with one hand under the lower mounting post. The upward pressure is necessary to relieve the threads of the mounting post while turning the nut.
- ⑧ Remove the shipping insert from the mounting post by removing the indexing pin and piston retaining nuts.
- ⑨ Install the piston-cylinder in the mounting post following the instructions in Section 6.3.6.

#### 3.3.10.2 CONNECT THE MANIFOLD AND VALVE 9

The bypass/control manifold is connected to the right side (viewed from the front) of the FPG8601 Platform. The manifold itself was already connected to the FPG8601 (see Section 3.3.4) and the piston-cylinder has already been installed (see Section 3.3.10.1).

- ❶ Connect the lower KF16 manifold tube to the KF16 low control port on the FPG8601 mounting post.
- ❷ Connect the FPG8601 vacuum isolation valve (valve 9) to the bottom of the lower mounting post at the KF25 connection. Mount the valve so that main body is vertical and the lateral KF25 port is to the left (viewed from the front).
- ❸ Connect the 1/8 in. pneumatic line labeled **9** from the FPG8601 vacuum isolation valve (valve 9) to the **V9** port on the front of the FPG8601.
- ❹ Level the FPG8601 using the bubble level on the top of the platform and the back two leveling feet.



### 3.3.10.3 INSTALL THE REFERENCE VACUUM CDG ASSEMBLY

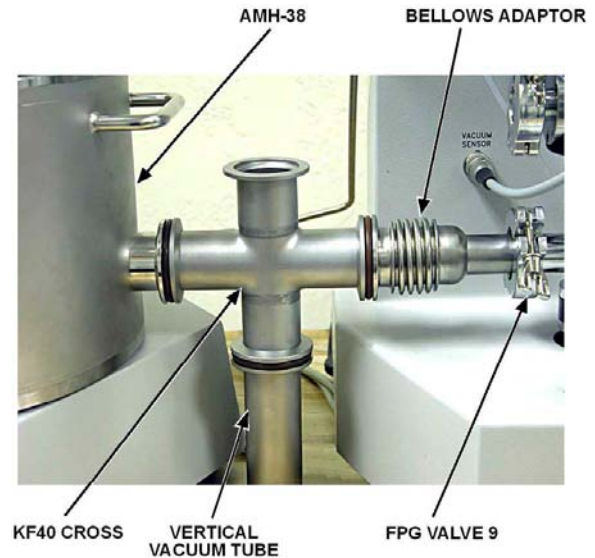


*The PG7601 and FPG8601 reference vacuum CDGs are delivered with an isolation valve connected to them. This valve is normally closed and serves to maintain vacuum on the CDG at all times as exposing the CDG to atmospheric pressure will cause zero shifts. New CDGs are shipped with vacuum behind the isolation valve. Do not break the valve fittings or operate the valve without establishing vacuum first.*

- ❶ Connect the FPG8601 reference vacuum CDG assembly (CDG, KF16 clamp/o-ring, KF16 pneumatic valve) to the KF16 port on the front of the mounting post. Install so that the CDG body is in the vertical position.
- ❷ Connect the CDG electrical cable to the **VACUUM SENSOR** electrical connector on the front of the FPG8601 platform.
- ❸ Connect the 1/8 in. pneumatic line labeled **12** from the CDG isolation valve (valve 12) to the **V12** port on the front of the FPG8601.

### 3.3.11 COMPLETE REFERENCE VACUUM INTERCONNECTIONS

- ❶ Connect the KF40 cross to the AMH-38 right side (viewed from front) KF40 fitting.
- ❷ Connect the KF40 cross to the vertical vacuum tube (that comes up through the bench). Adjust the position of the vertical tube if necessary by loosening and retightening the holding collar on the vertical tube brackets (under the bench).
- ❸ Connect the KF40 cross to the bellows adaptor KF40 connection.
- ❹ Connect the KF25 port on the bellows adaptor to the FPG8601 valve 9 KF25 port. It may be necessary to move the FPG slightly.
- ❺ Connect the KF40 blank-off cap to the top port of the KF40 cross.
- ❻ Verify the bubble level on top of the FPG8601 platform and re-level if necessary.



### 3.3.12 INSTALL THE UTILITY VACUUM PUMP

- ❶ Position the utility vacuum pump under the bench. The two scroll vacuum pumps provided are identical, so either one may be used here.
- ❷ Install a 3/8 in. Swage x 1/4 in. NPT M adaptor on the Control Cabinet **UTILITY VACUUM** port.
- ❸ Connect the utility pump inlet to the Control Cabinet **UTILITY VACUUM** port using the 3/8 in. PFA with 3/8 Swage x KF25 adaptor installed tube assembly.
- ❹ Connect the utility pump power cord to the **AC2 UTILITY PUMP** socket on the rear of the control cabinet.

### 3.3.13 SET UP THE SYSTEM CONTROLLER (PC)

The system controller is a standard personal computer with flat screen display, keyboard and pointing device. These may be installed on the computer stand supplied or at any other convenient location.

Connect the USB cable labeled **PC USB** that comes out of the back of the Control Cabinet to a USB port on the back of the system controller (PC).

## 3.4 POWER UP, INITIALIZATION, VERIFICATION

### 3.4.1 MAIN POWER SWITCHES

- 1 Turn ON the **INSTRUMENTS** power switch on the front, top, left of the Control Cabinet.

The (2) PP3 pressure controllers and the RPM4 reference pressure monitor in the Control Cabinet should initialize and go their main run screens. If they do not power up, check from the rear of the Control Cabinet that their power cords are properly connected and/or that the power switch on the power strip inside the Control Cabinet is ON.

- 2 Turn ON the **UTILITY PUMP** power switch on the front, top, left of the Control Cabinet. If the utility pump does not power up, check the power switch on the pump and turn it ON if necessary.
- 3 If **ADCS Tools** software is currently ON, be sure the current measurement mode is gauge. Turn ON the **REFERENCE PUMPS** power switch on the front, top, left of the Control Cabinet. The reference turbo and roughing pumps should NOT start up as ADCS Tools controls a relay on the circuit so that these pumps power up only when absolute measurement mode is set.

### 3.4.2 SET OR VERIFY DEVICE COMMUNICATION PORT AND OTHER SETTINGS

#### 3.4.2.1 COMMUNICATION PORTS

On the RPM4 A116K front panel use [**SPECIAL**], <2remote>, <1COM1> to set the COM1 port.

On the PPC3-200K A116K/BG15K front panel use [**SPECIAL**], <2remote>, <1COM1> and <2COM2> to set the COM1 and COM2 RS232 ports.

On the PPC3-700K front panel use [**SPECIAL**], <2remote>, <1COM1> and <2COM2> to set the COM1 and COM2 RS232 ports.

On the PG7601 Terminal front panel, use [**SPECIAL**], <5remote>, <1COM1>, <2COM2> (after COM2 select <1settings>) and <3COM3>, <to set the COM1, COM2 and COM3 RS232 ports.

The correct settings for all RS232 (COM) ports are.

**Baud** 9 600

**Parity** NONE

**Length** 8

**Stop Bit** 1

**Terminators** <CR><LF> (PG7601 only)

#### 3.4.2.2 PG7601 EXTERNAL VACUUM GAUGE COMMUNICATION

On the PG7601 Terminal front panel, select [**SPECIAL**], <5remote>, <2COM2>, <3vac>, <2user>.

When <COM2 meas req string> is displayed, use the [→] key to scroll through characters until a <p> is displayed. Then press [**ENT**] followed by [**ESC**]. Choose <2yes> in response to the <Save edits> prompt.

When <Reply conv coef> is displayed, press [**ENT**] to accept the value of <1.00 Pa/unit>.

When **<Leading characters to strip>** is displayed, press **[ENT]** to accept the value of **<0>**.

### 3.4.2.3 EDIT AND SELECT PG7601 SETUP FILE

On the PG7601 Terminal front panel, select **[SETUP]**, **<3edit>**.

When **<Edit SETUP file:>** is displayed, press **[ENT]** to accept **<#2 >**.

Then select **<7vac>**, **<4COM2>**. Press **[ESC]** and in response to **<Save as SETUP file:>** press **[ENT]** to accept **<#2 >**. This returns operation to the MAIN RUN screen.

Select **[SETUP]**, **<1select>**.

When **<Use SETUP file:>** is displayed, enter **<2>**.

**<Initializing extern vac sensor>** should be displayed briefly. If a failure message is displayed, check COM ports (see Section 3.4.2.1)

## 3.4.3 PG7601

### 3.4.3.1 POWER UP

In normal ADCS-601-AF operation, the PG7601 is controlled remotely by **ADCS Tools** software. For power up and initialization, the PG7601's PG7000 Terminal keypad and display are used.

Turn the PG7601 power ON by pressing the power ON/OFF switch on the rear panel of the PG7000 Terminal. Observe the display as the terminal connects with the PG7601 Platform, tests, initializes and goes to the main run screen.

If **<....Searching.....>** displays for more than 5 seconds, the communications between the PG7000 and the PG Terminal are failing. Check that the PG7601 to PG Terminal cable is properly installed.

If PG7601 fails to reach the main run screen, service may be required. Record the sequence of operations and displays observed and contact a **DHI** Authorized Service Provider (see Table 26).

### 3.4.3.2 INITIALIZATION

#### VERIFY THE PISTON-CYLINDER MODULE, MASS SET AND MASS LOADING BELL

PG7601 uses stored piston-cylinder and mass set metrological information to calculate the reference pressures it defines (see the PG7000 Operation and Maintenance Manual for more detail). For the pressure values to be correct, the stored metrological information on the piston-cylinder and mass set must be correct. Before using PG7601 for accurate pressure definition, the validity of the stored information should be verified. This consists of comparing the piston-cylinder and mass set information stored in PG7601 to the information in the current piston-cylinder and mass set calibration reports.

With a new ADCS-601-AF system, the piston-cylinder module and mass set information have already been loaded into the PG7601.

To verify the PG7601 piston-cylinder and mass set information, use the viewing capabilities accessed by pressing **[SPECIAL]**, **<1PC/MS>** on the PG7000 Terminal. Compare the information contained in the PG7601 piston-cylinder and mass set files to the information on the piston-cylinder and mass set calibration reports.

#### VERIFY SETUP FILE

PG7601 uses many variables in calculating defined pressures. The sources of the variables are determined by the current SETUP file. SETUP files are viewed, created, edited and selected using the SETUP function accessed by pressing **[SETUP]** on the PG7000 Terminal. ADCS-601-AF systems use SETUP file #2.

#### **VERIFY/SELECT AUTOGEN ON**

Press **[AutoGen]** on the PG7000 Terminal. AutoGen should be ON.

#### **VERIFY/SELECT AUTOROTATE ON**

Press **[Rotate]** on the PG7000 Terminal. AutoRotate should be ON.

#### **VERIFY AMBIENT CONDITION MEASUREMENTS**

PG7000 automatically measures ambient conditions and uses these conditions in its pressure calculations.

To verify that the ambient condition measurements are operating properly proceed as follows:

- **Display current ambient condition readings:** Press **[AMBIENT]** on the PG7000 Terminal. The ambient conditions run screen is displayed.
- **Verify proper ambient condition readings:** Compare the ambient condition values displayed to the actual values of ambient conditions. Refer to the PG7601 ambient condition measurement specifications when evaluating the ambient readings (see Section 1.1.2.1).

### **3.4.4 FPG8601**

#### **3.4.4.1 POWER UP**

Turn the FPG8601 power ON by pressing the power ON/OFF switch on the rear panel of the FPG8000 Terminal. Observe the display as the terminal connects with the FPG8000 Platform, tests, initializes and goes to the main run screen.

If **<....Searching.....>** displays for more than 5 seconds, the communications between the FPG8601 and the FPG Terminal are failing. Check that the FPG8601 to FPG Terminal cable is properly installed.

If the FPG Terminal fails to reach the main run screen, service may be required. Record the sequence of operations and displays observed and contact a **DHI** Authorized Service Provider (see Table 26).

### **3.4.5 START UP SYSTEM CONTROLLER AND SOFTWARE**

To start up the system controller proceed as follows:

- ❶ Turn ON the system controller using its power switch and wait for it to complete booting to the normal desktop.
- ❷ Run the **FPG Tools** program using the icon on the desktop. Once the **FPG Tool** program has completed booting, select **[Run]**, **[Run Monitor]**. During initialization select **<Gauge>** measurement mode. Wait for initialization to complete.
- ❸ Run the **ADCS Tools** program using the icon on the desktop. Select the **[ON]** button on the main **ADCS Toolbar** (see Section 4.3.3). **ADCS Tools** initializes the complete ADCS-601-AF system. Warnings that the system calibration has changed may appear. This is normal as **ADCS Tools** is writing to its database for the first time. Select **[OK]** in response to these warnings.
- ❹ Set system local gravity and test gas species in **ADCS Tools** following the instructions in Sections 3.5 and 3.6.





It is imperative that local gravity and test gas species be set correctly prior to ADCS-601-AF operation or out of tolerance measurement are likely.

- 5 Run manual FPG8601 internal calibration:
  - Access the **ADCS Tools FPG Run Screen** (see Section 4.3.6.2).
  - Press the FPG8601 internal calibration button. This button is identified by a wrench icon.
  - When the results windows appears, press **<Active the calibration>**.
- 6 ADCS-601-AF is now ready to operate. See Section 3.4.6 to verify operation before regular use.

### 3.4.6 VERIFY SYSTEM OPERATION

Once the ADCS-601-AF is fully assembled and powered up (see Section 3.3), the following steps may be used to verify operation:

- 1 Check gauge mode operation of the PG7601 and FPG8601 systems:
 

Plug the ADCS-601-AF **TEST(+)** port with the plug quick connector stem provided.

  - Set operation to gauge mode in **FPG Tools** (see Section 4.2.3).
  - Set a target pressure of 380 kPa (112 inHg) (see Section 4.2.4). The PG7601 should automatically load mass, use the PG7601 PPC3 pressure controller to increase pressure and float the PG7601 piston, rotate its piston and indicate *Ready*. Once *Ready* is indicated and about 30 seconds have been allowed for pressure stabilization, the drop rate of the PG7601 should not exceed  $-0.2$  mm/min. A faster drop rate value than  $-0.2$  mm/min indicates a possible leak.
  - Set a target pressure of 20 kPa (6 inHg). The PG7601 should change the mass load, use the PG7601 PPC3 pressure controller to decrease pressure and float its piston, rotate its piston and indicate *Ready*.
  - Set a target pressure of 10 kPa (3 inHg). The ADCS-601-AF will transition from the PG7601 to the FPG8601 standard. The FPG8601 pressure controller should descend pressure and set a stable pressure near the target pressure value and indicate *Ready*.
  - Set a target pressure of 1 kPa (0.2 inHg). The FPG8601 pressure controller should descend pressure and set a stable pressure near the target pressure and indicate *Ready*.
- 2 Check absolute mode operation.
  - Set ADCS-601-AF operation to absolute mode (see Section 4.2.3). Wait for the mode transition to complete. The reference vacuum value should descend to less than 1.5 Pa (11 mTorr) within 20 to 30 minutes.
  - Set a target pressure of 80 kPa (24 inHg) (see Section 4.2.4). The PG7601 should automatically load mass, use the PG7601 PPC3 pressure controller to decrease pressure and float its piston, rotate its piston and indicate *Ready*. Once *Ready* is indicated and about 30 seconds have been allowed for pressure stabilization, the drop rate of the PG7601 should not be positive. A positive value indicates a possible leak.
  - Set a target pressure of 30 kPa (9 inHg). The PG7601 should automatically load mass, use the PG7601 PPC3 pressure controller to decrease pressure and float its piston, rotate its piston and indicate *Ready*.

- Set a target pressure of 10 kPa (3 inHg). The ADCS-601-AF will transition from the PG7601 to the FPG8601 standard. The FPG8601 pressure controller should descend pressure and set a stable pressure near the target pressure value and indicate *Ready*.
  - Set a target pressure of 1 kPa (0.2 inHg). The FPG8601 pressure controller should descend pressure and set a stable pressure near the target pressure and indicate *Ready*. Note: It may take up to 3.5 to 4 minutes to obtain a ready condition for descending increments at very low absolute pressure.
- ③ Run an FPG validation in absolute mode (see Section 7.2.3).

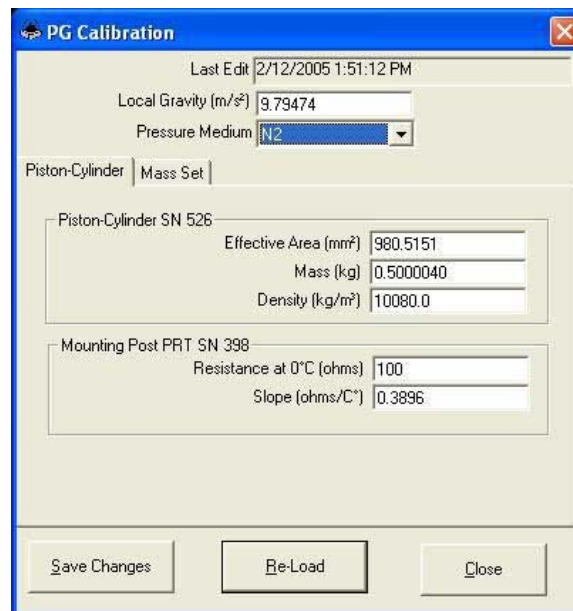
### 3.5 ENTER VALUE OF LOCAL GRAVITY

To correctly calculate the pressure defined by its PG7601 and FPG8601 pressure standards, local value of acceleration due to gravity must be known and entered into **ADCS Tools**.

To enter the local value of acceleration due to gravity into **ADCS Tools**, press **[Maintenance]** on the main menu and select **[Calibration]**. Edit the value of local gravity to enter gravity at the site of use of the ADCS-601-AF System (see Figure 28).



*See the PG7000 and FPG8601 Operation and Maintenance Manuals for additional information on how acceleration due to gravity is used in the calculation of defined pressure.*



**Figure 28.** Local gravity and pressure medium fields in ADCS Tools

## 3.6 SPECIFY TEST GAS SPECIES

The ADCS-601-AF system, and especially the FPG8601 pressure standard, are dependent upon the species of the test gas used.

The test gas used must be correctly specified in **ADCS Tools**.

To enter the test gas species into **ADCS Tools**, press **[Maintenance]** on the main menu and select **[Calibration]**. Select the test gas that is supplied to the ADCS-601-AF Control Cabinet **TEST GAS SUPPLY** port (see Figure 28). The gas choices are limited to Nitrogen and Air.

## 3.7 ADDITIONAL PRECAUTIONS TO TAKE BEFORE MAKING PRESSURE MEASUREMENTS

Before using ADCS-601-AF, consider the following:

- Enter the correct value of local gravity at the site of use in **ADCS Tools** (see Section 3.4.5).
- Consider head corrections (see Section 4.2.6).
- Level the PG7601 and FPG8601 Platforms properly using their bubble levels.
- Verify that the PG7601 piston-cylinder module is correctly cleaned and operating properly (see Section 6.6).
- Verify that there are NO leaks in the system connected to the test port.
- Assure that adequate metrological maintenance has been performed (see Section 7).

## 3.8 SHUT DOWN AND RESTART

### 3.8.1 RESTART

To restart an assembled ADCS-601-AF, follow the steps below. If the ADCS-601-AF has been shut down for an extended period, consider performing the maintenance functions (see Section 6).

- ❶ If they have been disconnected, connect and apply required pressure supplies to the Control Cabinet rear panel (see Section 1.1.1).
- ❷ Connect **AC1**, **AC2**, **AC3** power cords from Control Cabinet to power supplies. Turn ON main power switches (**INSTRUMENTS**, **REFERENCE PUMPS** and **UTILITY PUMP**) on front of Control Cabinet. The utility vacuum pump should start up, if not check its local power switch.
- ❸ Run the **FPG Tools** program on the system controller by selecting the **FPG Tools** icon on the desktop. Once the program has opened, select **[Run]**, **[Run Monitor]** to initialize the FPG8601. Wait for initialization to complete.
- ❹ Run the **ADCS Tools** program on the system controller by selecting the **ADCS Tools** icon on the desktop. Once the program has opened, press the **[ON]** button. Follow the prompts to complete the ADCS-601-AF initialization process. Select the desired measurement mode when the prompt appears.
- ❺ ADCS-601-AF should be ready for regular operation (see Section 4).

## 3.8.2 SHUT DOWN

---



Pressure must always be supplied to the TEST GAS SUPPLY port on the rear of the Control Cabinet unless the FPG8601 has been shut down following the long term shut down instructions in Section 3.8.2.2. Failure to supply pressure to the FPG8601 lubrication gas circuit will cause damage to the instrument.

---

There are two different standard ADCS-601-AF shut down conditions.

- 1) **Short term shut down:** Short term shut down is intended to limit power consumption and preserve vacuum pump life when the system is not used for limited periods of time such as overnight or over a weekend (see Section 3.8.2.1). Short term shut down may also be used for extended periods and is preferable to long term shut down if support facilities allow it.
- 2) **Long term shut down:** Long term shut down is intended to completely shut down the ADCS-601-AF system when it will not be used for extended periods of time or before it will be disassembled. Long term shut down should be avoided to the extent possible as restarting from long term shut down is more likely to require maintenance procedures before normal operation is restored.

### 3.8.2.1 SHORT TERM SHUT DOWN

To reduce consumption of power and preserve vacuum pump life, the following conditions may be implemented when the ADCS-601-AF is not in use, for example over the weekend. In this state, ADCS-601-AF is in gauge measurement mode with the utility vacuum pump turned off.

- ❶ Put system into gauge measurement mode by pressing the **[Measurement Mode]** button on the **ADCS Run Screen Toolbar** (see Section 4.3.5.3). If necessary, wait for the mode transition to complete.
- ❷ Turn OFF the **UTILITY PUMP** power switch on the front of the Control Cabinet. DO NOT disconnect pressure supplies. Pressure supplies must be maintained.



Utility vacuum must be supplied to the ADCS-601-AF for it to operate normally, even in gauge mode. Be sure to reestablish utility vacuum after a short term shut down. Failure to do so will prevent ADCS-601-AF from functioning properly.

---

### 3.8.2.2 LONG TERM SHUT DOWN

If the ADCS-601-AF will not be used for an extended period, or to shut it down completely for disassembly, proceed as follows.

- ❶ Complete the short term shut down (see Section 3.8.2.1).
- ❷ Use the **ADCS Tools [FPG]** button to display the FPG run screen. In the **ADCS Tools FPG Run Screen**, press the **[Shutdown]** (OFF) button.
- ❸ Wait for the FPG8601 to indicate *Ready* and the measured pressure to indicate **<-- SHUTDOWN -->** indicating the FPG is shut down.
- ❹ Disconnect pressure supplies and turn OFF power using main switches on front of Control Cabinet.

## 4. OPERATION

### 4.1 GENERAL OPERATING PRINCIPLES

#### 4.1.1 SYSTEM CONFIGURATION

The ADCS-601-AF system is completely configured from a hardware and software standpoint when it is delivered. All necessary operating values are entered into individual components and all interfaces are set for internal consistency and to communicate with **ADCS Tools** software.

The system hardware configuration can be viewed and edited using panels [**Setup**], [**Configuration**] form. Changes to the configuration should only be made when necessary by personnel with advanced knowledge of the system. Uninformed changes to the configuration are likely to cause ADCS-601-AF to no longer operate properly.

#### 4.1.2 READY/NOT READY INDICATIONS

##### 4.1.2.1 OVERVIEW

Typical ADCS-601-AF operation consists of using the system to set values of pressure with very low measurement uncertainty. A variety of operations by the ADCS-601-AF system may be required to achieve the requested pressure and the time required to complete these may vary. In order to make it clear to the operator when a pressure setting request has been completed and conditions are appropriate for the ADCS-601-AF pressure definition to be within the estimated measurement uncertainty budget, ADCS-601-AF provides a “go/no go” *Ready/Not Ready* indication.

The *Ready/Not Ready* indication is provided by the **ADCS Tools** software that manages the overall system (see Section 4.3). The indication is by a circle to the left of the current pressure reading which is RED when the pressure is *Not Ready* and *Green* when the pressure is *Ready*.

The conditions that must be met to reach a *Ready* condition vary depending upon whether the active pressure standard is the PG7601 piston gauge or the FPG8601 force balanced piston gauge. See Sections 4.1.2.2 and 4.1.2.3 for additional information on the *Ready/Not Ready* criteria for the two pressure standards.

##### 4.1.2.2 READY/NOT READY WHEN USING THE PG7601 PISTON GAUGE



*ADCS-601-AF uses the Ready/Not Ready directly from the PG7601 to determine the Ready/Not Ready condition. See the PG7000 Operation and Maintenance manual for a more detailed description of PG7000 Ready/Not Ready operation.*

When the PG7601 is the active pressure standard ADCS-601-AF pressure *Ready/Not Ready* depends directly upon the PG7601 *Ready/Not Ready* condition.

The PG7601 *Ready/Not Ready* condition is dependent upon three criteria. For the PG7601 pressure to be considered *Ready*, all three criteria must be met.

1. Piston position: For a *Ready* condition to exist, the PG7601's piston must be floating within the position limits defined in the PG7601's active SETUP file AND the PPC3 pressure controller is not controlling. The default PG7601 SETUP file is #2. The default piston position *Ready* limits are - 2.5 mm and + 2.5 mm of midstroke. The full stroke of the piston from top stop to bottom stop is + 4.5 to - 4.5 mm.
2. Piston rotation rate: For a *Ready* condition to exist, the PG7601's piston must be rotating at a rate within the rotation rate limits defined in the piston-cylinder's characteristics file. The default is 10 to 40 rpm. When the mass load on the PG7601 is < 3 kg (corresponds to pressure of < 30 kPa (9 inHg)) the maximum rate limit is removed.
3. Reference vacuum level in absolute mode: In absolute measurement mode, for a *Ready* condition to exist, the reference vacuum as measured by the reference vacuum capacitance diaphragm gauge must be lower than the vacuum limit specified in the PG7601's active SETUP file. The SETUP file is #2. The default minimum reference vacuum value is < 5 Pa (38 mTorr).

#### 4.1.2.3 READY/NOT READY WHEN USING THE FPG8601 FORCE BALANCED PISTON GAUGE

When the FPG8601 is the active pressure standard, ADCS-601-AF pressure *Ready/Not Ready* depends upon the value and stability of the pressure measured by the FPG8601 and the internal limits within **FPG Tools**. FPG8601 internal limits will force a *Not Ready* condition in the FPG8601 when ambient conditions have significantly changed since the last FPG8601 zero. A feature in the **[Maintenance],[FPG Cal Options]** menu is provided to decouple the FPG8601 internal limits and the *Ready/Not Ready* status of the ADCS-601-AF when the FPG8601 is the active reference (see Section 7.2).

When **Regulation** (see Section 4.1.4) is **OFF**, the ADCS-601-AF *Ready/Not Ready* condition when using the FPG8601 is dependent on:

1. FPG8601 pressure stability: For a *Ready* condition to exist, the FPG8601's pressure rate of change must be less than the FPG8601 stability criterion. The default FPG8601 stability criterion is  $\pm 0.5$  Pa/s (0.00015 inHg/s).

When **Regulation** (see Section 4.1.4) is **ON**, the ADCS-601-AF *Ready/Not Ready* condition when using the FPG8601 depends upon:

1. FPG8601 pressure hold limit: For a *Ready* condition to exist, the pressure measured by the FPG8601 must be inside of the FPG8601 pressure hold limit. The default hold limit is  $\pm 1.0$  Pa (0.0003 inHg).
2. FPG8601 pressure stability: The FPG8601 pressure stability criterion is not used to determine *Ready* when the ADCS-601-AF is actively controlling a pressure. When pressure control is aborted, a *Ready* condition will occur when the FPG8601's pressure rate of change is less than the FPG8601 stability criterion.

### 4.1.3 TRANSITION BETWEEN STANDARDS, ACTIVE AND INACTIVE STANDARD

The ADCS-601-AF system is made up of two automated pressure standards with overlapping ranges to cover the full pressure range. An automated PG7601 piston gauge covers the range of 15 to 380 kPa (4.5 to 120 inHg) (see Section 2.2.1). The PG7601 range is extended down to 1 kPa (0.3 inHg) by an FPG8601 force balanced piston gauge with automated pressure control (see Section 2.2.2).

In normal operation, the **ADCS Tools** software that manages the ADCS-601-AF system, determines which pressure standard system to use based on the pressure value to be set. **ADCS Tools** also handles the transition from one standard to the other when the requested pressure point requires changing the active pressure standard.

There is always an active pressure standard (see Table 11). Active is defined as connected to the ADCS-601-AF **TEST(+)** port. Changing the active pressure standard requires changing the states of the PG and FPG ISOLATION valves (valves 1 and 2) (see Figure 29) without causing excessive perturbation to the pressure applied to the **TEST(+)** port and the device under test. This is accomplished by using the two PPC3 pressure controllers to set the same pressure on either side of the isolation valve. Once this transition pressure has been set and stabilized, the valves are operated. The default transition pressure is 15 kPa in absolute mode and 14 kPa in gauge mode. The value can be changed in **ADCS Tools**, [**Setup**], [**Configuration**], [**Limits**] but this is not recommended.

The transition between standards is initiated automatically when a pressure request is made that requires the standard that is not currently active. A transition can also be initiated using the [**Standard Transition**] button on the **ADCS Run Screen Toolbar** (see Section 4.3.5.3).

Table 11. Valve states

Meas. mode	Active standard	Valve states (1 = open, 0 = closed)							Reference vacuum pumps
		1	2	4	6	9	10	11	
absolute	PG7601	1	0	0	0	1	1	1	on
	FPG8601	0	1	0	0	1	0	1	on
gauge	PG7601	1	0	1	1	1	1	1	off
	FPG8601	0	1	1	1	1	0	1	off

Note: For valve references, see Figure 29, ADCS-601-AF simplified operational schematic.

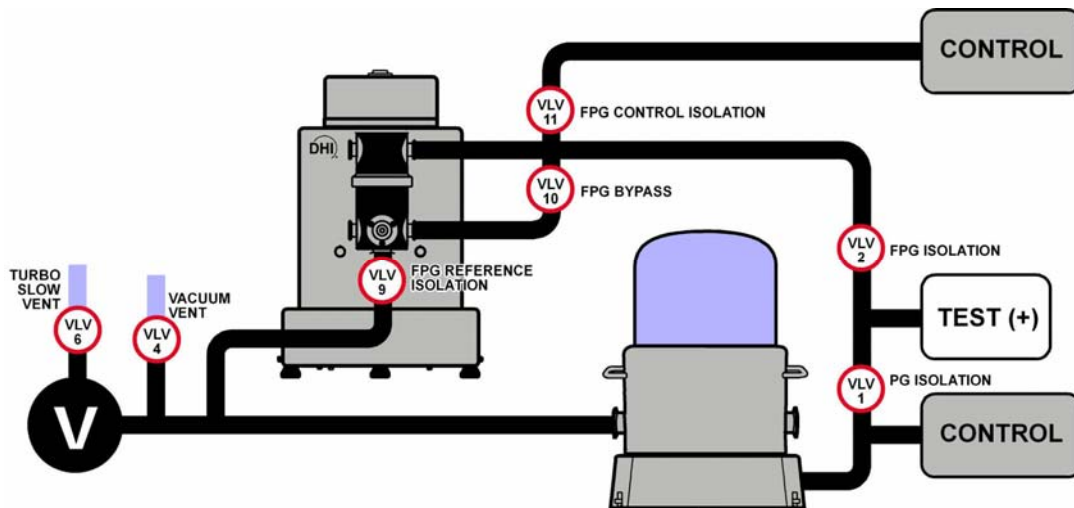


Figure 29. ADCS-601-AF simplified operational schematic

#### 4.1.4 DIFFERENCE BETWEEN REQUESTED AND ACTUAL SET PRESSURE

ADCS-601-AF is not designed to set exactly the pressure that has been requested. Rather, it sets a value of pressure very close to the requested pressure and returns the exact pressure value it has set.

The majority of the ADCS-601-AF pressure range (15 kPa (4.5 inHg) and up) is covered by an automated PG7601 piston gauge (see Section 2.2.1). The automated mass handling system of the PG7601 can load mass in steps of 0.1 kg. On the PG7601's 10 kPa/kg piston-



cylinder, 0.1 kg corresponds to increments of 1 kPa (0.3 inHg). When a pressure is requested of the PG7601, it calculates the mass to load to reach the pressure. It then loads the mass as closely as possible using its 0.1 kg resolution, calculates the actual pressure achieved and displays that value. Therefore, when using the PG7601, the actual pressure set may be up to 0.5 kPa (0.15 inHg) different from the pressure requested.

The FPG8601 pressure standard used to handle pressure requests under 15 kPa (4.5 inHg) (see Section 2.2.2) is normally used in a similar manner. The FPG8601's PPC3 pressure controller is commanded to set and stabilize the requested pressure. Due to the possible difference between the PPC3's pressure transducer and the FPG8601, the final pressure set by the PPC3 will not be exactly the requested pressure as read by the FPG8601. Since the FPG8601 is the pressure standard and has much lower measurement uncertainty than the PPC3's transducer, the FPG8601's reading is displayed as the ADCS-601-AF pressure value.

When using the FPG8601 (pressure points under 15 kPa (4.5 inHg)), it is possible to set exactly the requested pressure by using **Regulation** mode. In **Regulation** mode, the PPC3 pressure target is iteratively adjusted by the difference between the PPC3 pressure transducer reading and the FPG8601 reading to cause the FPG8601 to read the requested value of pressure within the FPG8601 pressure hold limit. See Section 4.1.2.3 for information on pressure *Ready/Not Ready* criteria when using FPG8601 with **Regulation** mode ON and OFF. **Regulation** mode can be turned ON and OFF in the **ADCS Tools Run Screen Control Panel** when the FPG8601 is the active pressure standard (see Section 4.3.5.1).

## 4.1.5 ASOLUTE AND GAUGE MEASUREMENT MODES

ADCS-601-AF can operate in two measurement modes.

In **absolute mode** pressure is defined relative to a vacuum. Vacuum is provided by the system reference vacuum pumps and is applied to the reference circuit of the pressure standards (see Figure 29). The residual vacuum level is ready by the PG7601 and FPG8601 reference vacuum CDGs.

In **gauge mode** pressure is defined relative to atmosphere. The reference vacuum pumps are turned OFF or isolated and the reference circuit of the pressure standards is opened to atmosphere. The DUT may be connected to the reference circuit on the **TEST(-)** port to assure that the DUT and pressure standards are at a common reference pressure.

See Section 4.2.3 for additional information on changing measurement modes.



*There is a well defined order of operation for transitioning the ADCS-601-AF system between measurement modes. The order is controlled by the ADCS Tools software. Mode transitions should only be performed under ADCS Tools control. Vacuum pumps must always be left ON in absolute mode. Before turning OFF vacuum pumps or disconnecting vacuum supplies, transition to gauge mode. Once a measurement mode change is initiated, it should be allowed to complete uninterrupted.*

---

## 4.2 FREQUENTLY USED FUNCTIONS

Regular ADCS-601-AF operations relating to connecting and disconnecting devices under test and setting pressures are performed from the **ADCS Tools ADCS Run Screen** (see Section 4.3.5).

How to perform common ADCS-601-AF functions is summarized in Sections 4.2.1 to 4.2.8).



## 4.2.1 CONNECTING A DEVICE UNDER TEST (DUT)



The ADCS-TEST(+) port should never be pneumatically accessed (make or break connection) unless the ADCS is “vented” following the instructions below. Damage to the system and/or the DUT may result from opening the TEST(+) port in other than “vented” condition.

The device or devices under test (DUT) are connected to the **TEST** port(s) at the front of the ADCS-601-AF Reference Bench.

Absolute measurement mode devices are connected to the **TEST(+)** port only. For gauge or “differential” mode devices the high side is connected to the **TEST(+)** and the low side is connected to the **TEST(-)** port. The **TEST(-)** port is at atmospheric pressure when the ADCS-601-AF is in gauge mode.

The **TEST** port connections are self sealing quick connectors (with no quick connector stem installed, they are closed). To connect, use one of the quick connector stems supplied with the ADCS-601-AF accessories. For proper ADCS-601-AF operation it is important that the system connected to the **TEST** port(s) be leak free and the volume connected to the **TEST (+)** port not exceed 1 liter (61 in.<sup>3</sup>). When operating ADCS-601-AF with nothing connected to the **TEST (+)** port, the quick connector plug supplied should always be used to seal it. Though the quick connectors are self sealing, they may leak.

**To access the test port, it must be vented to atmosphere.**

**In gauge measurement mode:** the **TEST(-)** port is always vented. To vent the **TEST(+)** port, press the **[VENT]** button on the **ADCS Run Screen Toolbar** (see Section 4.3.5.3) and wait for the vent process to complete (indicated **<Pressure>** is **<0.000>** and *Ready*). The **TEST(+)** port can then be accessed safely without damage to the DUT or the system.

**In absolute measurement mode:** The **TEST(-)** is not used and in an unknown state. To vent the **TEST(+)** port, press the **[VENT]** button on the **Run Screen Toolbar** (see Section 4.3.5.3) and wait for the vent process to complete (indicated **<Pressure>** is **< --- VENT --- >** and *Ready*). The **TEST(+)** port can then be accessed safely.

## 4.2.2 CHANGING PRESSURE UNIT OF MEASURE

ADCS-601-AF supports a variety of pressure units of measure. To change the pressure unit for the ADCS pressure, press the **[Unit of Measure]** button on the **ADCS Run Screen Toolbar** (see Section 4.3.5.3) and select the desired unit. When the ADCS pressure unit of measure is changed, the unit of measure of the ADCS-601-AF components (RPM pressure monitor, PPC pressure controllers) is also changed, if the unit selected is supported by the component. If the unit is not supported by the component, the component does not make a unit of measure change.

A shortcut to changing pressure unit of measure is to click on the pressure value. If the pressure unit shortcut is supported for that value, a pop menu gives the change unit option.

Note that the pressure unit of measure for the values of **<ATM>** (atmospheric pressure) and **<Reference Vacuum>** are set separately from the rest of the ADCS pressure value units.



For information on the pressure conversion calculations used by ADCS-601-AF, see Section 9.1.1.

### 4.2.3 CHANGING MEASUREMENT MODE (ABSOLUTE, GAUGE)



There is a well defined order of operation for transitioning the ADCS-601-AF system between measurement modes. The order is controlled by the ADCS Tools software. Mode transitions should only be performed under ADCS Tools control. Vacuum pumps must always be left ON in absolute mode. Before turning OFF vacuum pumps or disconnecting vacuum supplies, transition to gauge mode.



The current ADCS-601-AF measurement mode is indicated by:

- <a> (absolute) or <g> (gauge) following the pressure unit of measure in the ADCS Control Panel <Pressure> field (see Section 4.3.5.1).
- The color of the pressure standard reference pressure circuit and PG7601 bell jar in the ADCS System Display. light blue = gauge mode (atmospheric reference), black = absolute mode (vacuum reference) (see Section 4.3.5.2).
- The value displayed in the ADCS Run Screen Control Panel <Reference Vacuum> field. <N/A>= gauge mode; numerical value = absolute mode (see Section 4.3.5.1).

The complete ADCS-601-AF system is always in either absolute or gauge measurement mode. Target pressure requests are interpreted and set in the active measurement mode. In absolute mode the ADCS-601-AF pressure standard reference pressure circuit is pulled down to vacuum by the reference vacuum system. In gauge mode, the reference pressure circuit is open to atmospheric pressure.

To change the ADCS-601-AF measurement mode from gauge to absolute or absolute to gauge, **press the down arrow next to the [MEASUREMENT MODE] button on the ADCS Main Run Screen Toolbar** (see Section 4.3.5.3). The **ADCS Main Run Screen <Pressure> field displays < ---Measurement Mode Transition--- >** while the ADCS-601-AF system makes the changes necessary to change measurement modes. Do not attempt any other operations until the measurement mode transition is complete, as indicated by the <Pressure> field no longer indicating < ---Measurement Mode Transition--- > and the **Status Bar** (see Section 4.3.4) no longer indicating transition activities. This process may require several minutes to complete.

After a measurement mode change, the ADCS pressure (pressure on **TEST(+)** port) is always vented to atmosphere.

Pressing the **[MEASUREMENT MODE]** button itself, rather than the down arrow next to it, is used to reset the current measurement mode.

### 4.2.4 SETTING PRESSURES



Before setting a pressure, be sure that the TEST(+) port is not open to atmosphere or connected to a system with a very large leak. Execution of certain pressure requests could damage the ADCS-601-AF system if the TEST(+) port is open. If nothing is connected to the TEST(+) port, it must be plugged with the plug quick connect stem provided.

To set a pressure with ADCS-601-AF, first verify that ADCS-601-AF is in the desired measurement mode (gauge or absolute) (see Section 4.2.3) and that the **TEST(+)** port is not open to atmosphere. If nothing is connected to the **TEST(+)** port, it should be plugged with the plug quick connector stem provided.

Enter the desired target pressure in the **ADCS Control Panel <Target Pressure> field** and press **[ENTER]** on the system controller (PC). Observe the **ADCS Status Bar** and **System Display** for information on progress in setting the requested pressure (see Section 4.3.1). When

the requested pressure has been set and stabilized, a *Ready* indication is given (see Section 4.1.1) and the actual value of the set pressure is displayed in the **<Pressure>** field. In most cases, the final set pressure is not exactly equal to the target pressure (see Section 4.1.4).

#### 4.2.4.1 SETTING ZERO PRESSURE

##### Setting zero in absolute measurement mode

In absolute measurement mode, entering a target pressure of zero transitions the active pressure standard to the FPG8601 if it is not already active, controls down using the FPG's PPC3 pressure controller to the pressure defined in **[Setup]**, **[Configuration]**, **[Limits]** and then opens the FPG bypass valve (see Figure 29). This causes the pressure on the FPG8601 and at the ADCS-601-AF **TEST(+)** port, to be pulled down as low as possible directly by the reference vacuum pump system. The pressure achieved is indicated in the **ADCS Control Panel <Pressure>** field. *Ready* is indicated when the FPG8601 stability criterion is reached.

##### Setting zero in gauge measurement mode

The result of entering zero as the target pressure in gauge measurement mode depends upon a **[Maintenance]**, **[FPG Cal Options]** selection (see Section 4.3.2).

If the **<Vent using the FPG in gauge measurement mode>** option IS NOT selected, the active pressure standard is transitioned to PG7601 if it is not already active and the PG7601's PPC3 controller vents to atmosphere setting zero gauge pressure. The ADCS Control Panel **<Pressure>** field is fixed to **<0.000>**. This is the default setting.

If the **<Vent using the FPG in gauge measurement mode>** option IS selected, the active pressure standard is transitioned to FPG8601 if it is not already active and the FPG8601's PPC3 controller vents to atmosphere setting zero gauge pressure. The ADCS Control Panel **<Pressure>** field indicates the reading of the FPG8601.

#### 4.2.4.2 SETTING IDLE STATUS



*This section describes the ADCS-601-AF idle condition. The system can be left in this condition indefinitely but the system must remain powered ON and supplied with pressure and vacuum. See Section 3.7 for information on ADCS-601-AF system short and long term shut down procedures.*

In the normal idle (resting) condition of the ADCS-601-AF system, the pressure applied to the **TEST(+)** port is vented. This can be accomplished by pressing the **ADCS Run Screen Toolbar [VENT]** button (see Section 4.3.5.3) or setting a target pressure of zero in gauge measurement mode (see Section 4.2.4.1).

When vented in absolute mode, the **ADCS Control Panel <Pressure>** field indicates **< --- VENT --- >** and the pressure is *Ready*. When vented in gauge mode, the **<Pressure>** field indicates **<0.000>** and the pressure is *Ready*.

#### 4.2.5 PRESSURE EXERCISING THE DEVICE UNDER TEST

Many devices require pressure exercising prior to validation or calibration. Generally, their exercising can be performed quickly and without precise knowledge of the endpoint pressures. ADCS-601-AF supports a function to allow simple, rapid exercising of the DUT. The exercise function uses the PG7601's pressure controller alone rather than the pressure standards.

To run an exercise routine, press the **[Exercise Pressure]** button on the **ADCS Run Screen Toolbar** (see Section 4.3.5.3). Then fill in the form to define the desired exercise routine (see Figure 30).

The **<Dwell>** is a wait time at the maximum pressure for each cycle. The **<Control Timeout>** is the amount of time **ADCS Tools** will attempt to set a required pressure before giving up and continuing if it is unsuccessful.

After defining the exercise routine, press **[OK]** to proceed with the exercise routine. To interrupt the routine, use the **[Abort]** button on the **Main Toolbar** (see Section 4.3.3) or the **[Abort Control]** button on the **ADCS Run Screen Toolbar** (see Section 4.3.5.3).

Figure 30. ADCS Tools pressure exercise definition form

## 4.2.6 SETTING A HEAD CORRECTION

ADCS-601-AF can automatically correct for the difference in height between the ADCS-601-AF reference level and the reference level of a device under test (DUT). The head correction, adds or subtracts the pressure corresponding to a difference in height by calculating the pressure head using the density of the test gas at the measured pressure.

The reference level of the ADCS-601-AF system is the reference level of the PG7601 piston gauge which is marked on the front of the AMH automated mass handler vacuum chamber.

The difference in height between the ADCS-601-AF reference level and the DUT reference level, is entered in the **ADCS Control Panel <Head Correction>** field. The value is positive if the DUT reference level is higher than the ADCS reference level and negative if the DUT is lower than the ADCS. The value is always entered in centimeters (cm).

## 4.2.7 STOPPING PRESSURE CONTROL, ABORTING FUNCTION EXECUTION

To abort current pressure control, press the **[Abort Control]** button on the ADCS Run Screen Toolbar (see Section 4.3.5.3). This causes the PPC3 pressure controller to stop actively controlling and shut off from the system. To resume, a new target pressure must be entered.

To abort execution of a function (e.g. pressure standard change, measurement mode change, FPG8601 validation, press the **[Abort]** on the **ADCS Main Toolbar**. This causes execution of the function to stop. Nothing further occurs until a new instruction is given. The **ADCS Main Toolbar [Abort]** button is only available when a function that can be aborted is running.



*Aborting execution of a measurement mode change may leave the system in an <Unknown Measurement Mode> state. If this occurs, set a measurement mode (see Section 4.2.3) before attempting any other operation.*

The **ADCS Main Toolbar** has a **[Pause]** button. This button is to pause system operation. To resume operation after pressing **[Pause]**, press **[Pause]** again.

## 4.2.8 SECURITY, USER RIGHTS

The **ADCS Tools** program that runs the ADCS-601-AF system includes provisions to protect against undesired editing and changes to program parameters. The protection system is based on user rights.

**ADCS Tools** always has an active user. User access can be password protected. User rights can be managed to prevent a user from being able to make changes in specific areas of **ADCS Tools**.

See Table 12 for a description of the User Access areas that can be limited by management of user rights.

The typical set up of **ADCS Tools** to manager user rights is for the “Admin” user to be password controlled and only used by the system manager. The system manager can then set up and delete specific users with user passwords as desired.

**Table 12.** User rights user access areas

USER ACCESS AREA	RIGHTS DENIED IF THIS AREA IS NOT ACCESSIBLE
Calibration	[Maintenance], [Calibration] may be viewed but no changes can be saved.
Configuration	[Setup], [Configuration] may be viewed but no changes can be saved.
FPG Options	[Maintenance], [FPG Options] may be viewed but no changes can be saved.
ADCS PG Sensors	[Maintenance], [PG Sensors] may be viewed but no changes can be saved.
DUT	[Setup], [DUT] may be viewed but no changes, additions or deletions to DUT definitions can be made.
Edit Plots	The option to edit plots is available on the <b>Plot Form</b> but no changes can be saved.
Program Options	[Tools],[Test Options] may be viewed but no changes can be saved.
Support Device	[Setup], [Support Device] may be viewed but no changes, additions or deletions to support device definitions can be made.
Test	[Setup], [Test] may be viewed but no changes, additions or deletions to test definitions can be made.
Users	Access to [Setup], [Setup Users] is not available.

### 4.2.8.1 SETTING UP USERS AND MANAGING USER RIGHTS

When **ADCS Tools** is first installed, two users are already set up.

1. User name: Admin  
Password: None  
User access: All

NOTE: This user cannot be deleted or edited. To prevent unintended use of the Admin user, change its password.

2. User name: Test User  
Password: None  
User access: DUT, Edit Plots, Features, Program Options

To set up or delete users or to edit user rights or passwords, the active user must have access to the **<Users>** access area. The “Admin” user always has this access.

To manage users and user rights select **[Setup], [Setup Users]** from the **ADCS Tools** main menu.

To create a new user, press the **[Create]** button. The red, flashing **<Editing User>** bar appears. Edit **<User Name>** and **<Password>** as desired. Use the checkbox list under **<User Access>** to grant access to user areas (see Table 12). When editing is complete, press the **[Save]** button to save the new user.

To delete a user, select the user from the **<Supported Users>** list and then press the **[DELETE]** button.

To edit a user, select the user from the **<Supported Users>** list and then begin editing as desired. The red, flashing **<Editing User>** bar appears. When editing is complete, press the **[Save]** button to save the new user.

#### 4.2.8.2 CHANGING ACTIVE USER

When **ADCS Tools** is started up a user must be specified in the **[User Login]** dialog box.

To change active users, press **[Setup]**, **[Change Current User]** to cause the **[User Login]** dialog box to appear.

### 4.2.9 PRESSURE LEAK TEST

It is good practice to run a leak test on the ADCS-601-AF after performing a setup or maintenance operation that requires pressure fittings to be disconnected. The leak test can quickly determine if the ADCS-601-AF is performing properly. A report detailing the status of the individual portions of the leak test is provided upon test completion. The information in this report is used to isolate leaks in the ADCS-601-AF system (see Figure 31).

To run a pressure leak test, first put in the ADCS-601-AF in absolute measurement mode (see Section 4.2.3). After at least one hour in absolute mode, press the **[Leak Test]** button on the **ADCS Run Screen Toolbar** (see Section 4.3.5.3). User confirmation is required to ensure that there are no DUTs connected to the ADCS-601-AF that cannot support the leak test pressure. During the leak test, pressures of 375 kPa (110.7 inHg) and 15 kPa (4.4 inHg) are set.



*Do not attempt to run a leak test until the ADCS-601-AF has been in absolute measurement mode for at least 1 hour. The residual vacuum reference can change significantly during the first hour of absolute measurement mode operation after transitioning from gauge measurement mode. This change in pressure can cause the leak test to fail.*

---

There are three parts to the leak test: PG7601 drop rate test, residual vacuum test and FPG lubrication flow test. If any part of the leak test fails, the overall leak test fails.

The PG7601 drop rate portion of the leak test sets a high and low pressure with the PG7601. After stability is achieved the change in piston position over a 30s interval is used to determine the drop rate of the piston-cylinder. The recorded drop rates are compared to factory defined drop rate limits to determine a PASS/FAIL status. A high piston drop rate indicates a leak in the pressure circuit that interconnects the TEST(+) port, the PG7601 and the PG7601 pressure controller.

The residual vacuum portion of the leak test records the FPG8601 and PG7601 vacuum reference sensor outputs when the FPG8601 bypass valve is closed. The residual vacuum test is executed during the high pressure portion of the PG7601 drop rate test. The recorded residual vacuum pressures and the difference between them must fall below factory determined limits to pass the residual vacuum portion of the leak test. The residual vacuum test fails when a leak into the vacuum reference circuit is present.

The FPG8601 lubrication flow portion of the leak test is executed while the PG7601 drop rate test is setting the high pressure. In this test, the FPG8601 bypass valve is closed to monitor the rate of increase in the FPG8601 pressure due to the lubrication flow. Without pressure control, the FPG8601 pressure increases as a result of the FPG8601 lubrication flow when the FPG8601 bypass valve is closed. The change in the indicated FPG8601 pressure is recorded over a 30s interval to determine the pressure rate of change caused by the lubrication flow. The recorded value must fall below factory defined limits to pass the



FPG8601 lubrication flow portion of the test. A failure indicates a leak in the pressure circuit which interconnects the upper FPG8601 mounting post, the FPG8601 pressure controller (PPC3), and the FPG8601 isolation valve (valve 2).

The screenshot shows a window titled "Leak Test Results" with a sub-header "Leak Test". It displays the following information:

```

Test Date 10/13/2005 13:22
Active User Admin

[Piston Drop Rate]
Pressure      Drop Rate      Limit      Status
375.0 kPa    -0.04 mm/min  0.30 mm/min  PASS
15.0 kPa     0.01 mm/min  0.03 mm/min  PASS
  
```

At the bottom of the window are two buttons: "Print" and "Close".

Figure 31. ADCS Tools pressure leak test results form

## 4.3 LOCAL OPERATION, ADCS TOOLS

### 4.3.1 OVERVIEW

**ADCS Tools**, running on a personal computer, is the software program that controls the overall ADCS-601-AF system (see Figure 32). **ADCS Tools** communicates with other software programs and system instruments, providing instructions and reading their responses to execute ADCS-601-AF system functions.

**ADCS Tools** also provides the local user interface through the system controller's display, keyboard and pointing device. Direct operator interaction with ADCS-601-AF system subprograms and individual system instruments is not required in normal operation.

Operator interaction with the **ADCS Tools** program is through four main program features that follow conventional Microsoft® Windows™ protocol for file management, menu and message formatting, graphics and editing. The **ADCS Tools** features are:

1. **Main Menu (see Section 4.3.2):** The **Main Menu** is a bar across the top of the **ADCS Tools** program window. Each main menu selection leads to a drop down menu.
2. **ADCS Main Toolbar (see Section 4.3.3):** The **Main Toolbar** is across the top of the screen just under the **Main Menu**. The toolbar is made up of buttons that are shortcuts to ADCS menu items and functions.
3. **ADCS Status Bar (see Section 4.3.4):** The **Status Bar** is across the bottom of the **ADCS Tools** program window. It continually displays current ADCS system activity at multiple levels. The **ADCS Status Bar** is the best source of information on what the ADCS-601-AF system is doing at any particular moment.
4. **ADCS Run Screen (see Section 4.3.5):** The **Run Screen** is the main operator interface for actually running the ADCS-601-AF system. It is equivalent to the front panel of an instrument and includes real time ADCS-601-AF displays and controls. The **ADCS Run Screen** includes the **ADCS Control Panel**, **ADCS System Display** and **ADCS Run Screen Toolbar**.
5. **Other Run Screens (see Section 4.3.6):** Run screens are available for individual ADCS system components with which **ADCS Tools** communicates directly. Plot and Data Grid screens are also available to view data while tests are running.



To start up ADCS Tools, see Section 3.8.1.

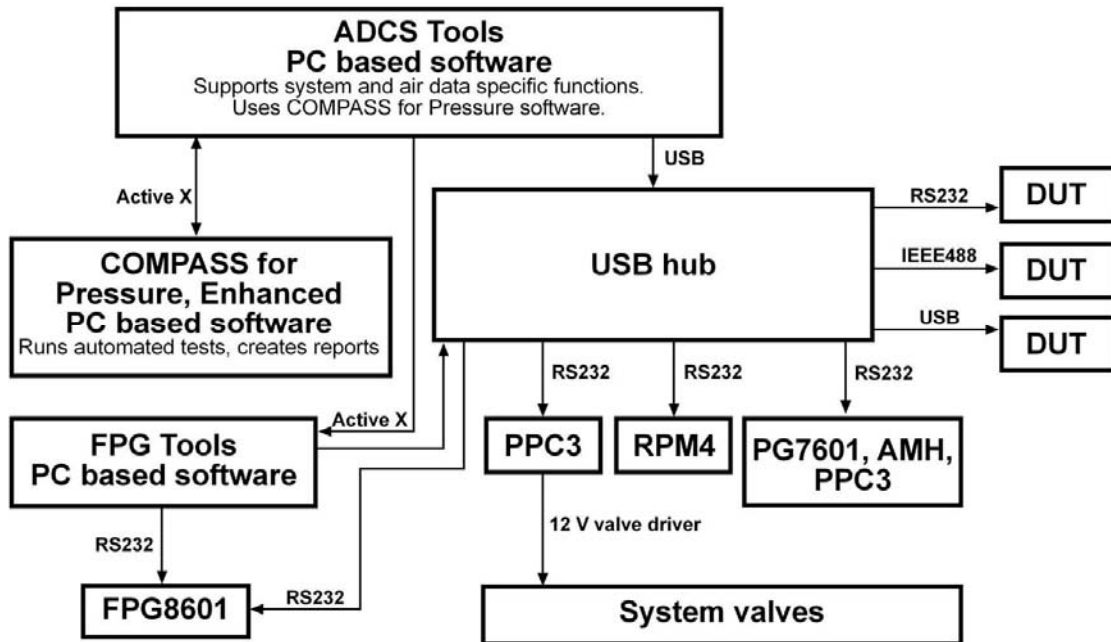


Figure 32. ADCS-601-AF software, communications and control flow chart

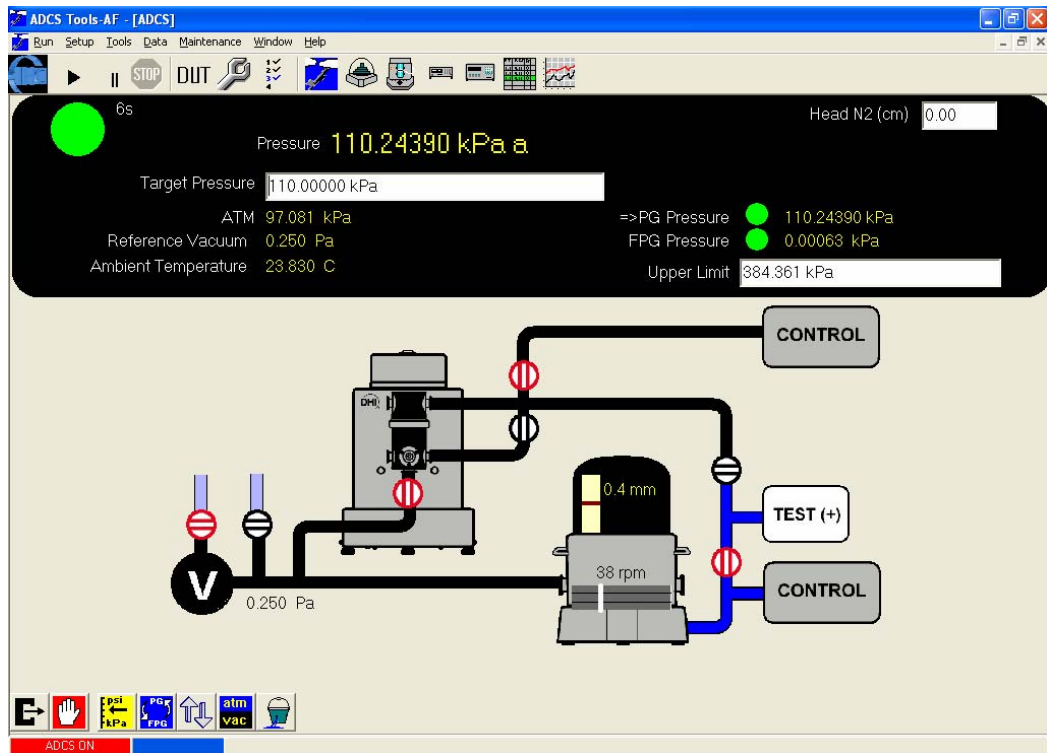


Figure 33. ADCS-601-AF program window



### 4.3.2 MAIN MENU

The **ADCS Main Menu** is a bar across the top of the **ADCS Tools** program window. Each main menu selection leads to a drop down menu.

Table 13 summarizes the **Main Menu** and its sub-menus.

**Table 13. ADCS Tools Main Menu and sub-menus summary**

MAIN MENU ITEM	SUB-MENU ITEM	DESCRIPTION	SEE SECTION
<u>R</u> un	Start ADCS or <u>S</u> top ADCS	<b>[Start ADCS]</b> starts operation of the ADCS-601-AF system, establishing communication with system components and initializing the system. System power must be ON, pressure sources must be applied and <b>FPG Tools</b> software must be running before <b>[Start ADCS]</b> is selected.  <b>[Stop ADCS]</b> stops operation of ADCS-601-AF interrupting communication between <b>ADCS Tools</b> and system components.	3.4.5
	Run <u>T</u> est Definition	Start execution of a predefined Test Definition sequence.	4.4.2.1
	Run <u>M</u> anual Test	Start execution of a test with data logging but with no predefined sequence.	4.4.2.2
	<u>E</u> xit Program	Shut down the <b>ADCS Tools</b> and exit the program. Do not use this option without reading shut down procedure in Section 3.8.	3.8
<u>S</u> etup	<u>T</u> est	Set up predefined test sequences for selection and execution using <b>[Run]</b> , <b>[Run Test Definition]</b> .	4.4.1.2
	<u>D</u> UT	Set up of DUTs to be tested.	4.4.1.1
	<u>S</u> upport Device	Set up of instruments/devices to be used in running tests that are not DUTs, for example a multimeter to read DUT output.	4.4.1.3
	<u>C</u> onfiguration	Set up ADCS-601-AF system instruments and adjust test parameters.	4.1.1
	<u>U</u> sers	Set up ADCS-601-AF system users and manage their passwords and rights.	4.2.8
	<u>C</u> hange Current User	Change the current ADCS-601-AF user.	4.2.8.2
<u>T</u> ools	<u>T</u> est Options	Set up options relating to managing data collected when running a test and how tests end.	4.4.1.4
	<u>R</u> emote Communications	Send and receive remote commands manually using the Direct Remote Communication tool.	N/A
	<u>U</u> nit of measure Converter	Run the Unit of Measure Converter. This tool not only acts as a convenient unit converter, it also provides the ability to create custom pressure units.	N/A
<u>D</u> ata	<u>V</u> iew Data File	View data files created by running tests or FPG validations.	4.4.3.3
	<u>P</u> lot Data File	Plot the information in a data file.	4.4.3.3
	<u>D</u> atabase Data Viewer	Sort, plot and display stored test data.	4.4.3.3
	<u>W</u> rite Data File to Database	Add an existing test Data File to the Test Data Database. This is a shortcut to the feature available in the Database Data Viewer.	4.4.3.3
	<u>R</u> eport Editor	Run the Report Editor to generate a report from a test Data File or data stored in the Test Data Database.	4.4.5
<u>M</u> aintenance	<u>F</u> PG Cal Options	FPG8601 zeroing and spanning run time options.	7.2.2
	<u>P</u> G Sensors	Display and adjust PG7601 ambient conditions sensors.	7.2.7
	<u>C</u> alibration	View and edit calibration values for active PG7601 piston-cylinder and mass set. View and edit value of local gravity used by PG7601 and FPG8601. View and edit species of test gas used in ADCS-601-AF system.	7.3.2, 7.3.3, 3.5, 3.6
	<u>R</u> un FPG Validation	Run automated routine to validate FPG8601 with PG7601.	7.2.3

MAIN MENU ITEM	SUB-MENU ITEM	DESCRIPTION	SEE SECTION
	Run CDG <u>Z</u> ero	Run a routine to zero the PG7601 and FP8601 reference vacuum CDGs relative to a vacuum standard.	7.2.6
	PG <u>P</u> PC <u>A</u> djust	Run a routine to adjust the PG7601's PPC3 pressure controller relative to the PG7601.	6.10
	FPG PPC <u>A</u> djust	Run a routine to adjust the FPG8601's PPC3 pressure controller Q-RPTs relative to the FPG8601.	6.10
	PG Internal Vacuum <u>Z</u> ero	Run a routine to adjust the PG7601's internal vacuum gauge relative to its external CDG	6.9
<u>W</u> indow		Conventional Windows screen organization options.	N/A
<u>H</u> elp		Information about ADCS Tools.	N/A

### 4.3.3 ADCS MAIN TOOLBARS

The **ADCS Main Toolbar** is located across the top of the screen just under the Main Menu.

The **ADCS Main Toolbar** contents vary for different operations. The three possible toolbar configurations and the operation of their buttons are summarized in **Table 14**.



Manual operation toolbar





Running a manual test main toolbar (see Section 4.4.2.1)
















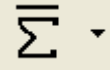
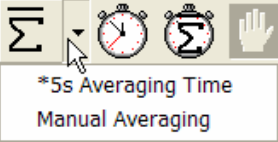



Running a test definition toolbar (see Section 4.4.2.2)




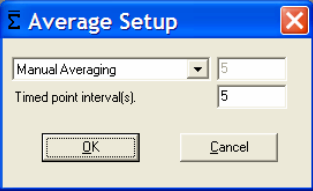






**Figure 34.** ADCS Main Toolbar

**Table 14.** ADCS Main Toolbar buttons

BUTTON	DESCRIPTION	SEE SECTION
Rotating DHI logo or ON button	Located at far left of the Toolbar. Shows a rotating DHI logo when the <b>ADCS Tools</b> program is running normally. Stops rotating if the system software has been paused or the computer has experienced a fatal fault. Shows an ON button when the <b>ADCS Tools</b> program is NOT running. Press the ON button to start <b>ADCS Tools</b> (see Section 3.8.1 before starting <b>ADCS Tools</b> ).	N/A
Run Test 	Shortcut to the <b>[Run]</b> , <b>[Run Test Definition]</b> menu choice. When <b>ADCS Tools</b> is running a test, this option is disabled.	4.4.2.1
Pause 	Causes communications between <b>ADCS Tools</b> and system components to pause, suspending most operation. To restart, when paused, press pause again When running a test, suspends test execution and pauses test timers.	4.4.2

BUTTON	DESCRIPTION	SEE SECTION
<b>Abort</b> 	<p>Aborts sequential operations and functions such as changing measurement modes or transitioning pressure standards.</p> <p>This feature can be used to cut short certain operations such as the FPG8601 Purge.</p> <p>When running a test causes the <b>&lt;Abort Test&gt;</b> confirmation pop-up to appear.</p>	N/A
<b>Device Under Test (DUT)</b> 	<p>When running a test, allows the characteristics of the DUT to be viewed.</p> <p>When not running a test, is a shortcut to the <b>DUT Editor</b>.</p>	4.4.1.1
<b>Support Device</b> 	<p>When running a test, allows the characteristics of a support device to be viewed.</p> <p>When not running a test, is a shortcut to the <b>Support Device Editor</b>.</p>	4.4.1.3
<b>Test</b> 	<p>When running a test, allows the characteristics of the running test to be viewed.</p> <p>When not running a test, is a shortcut to the <b>Test Definition Editor</b>.</p>	4.4.1.2
<b>ADCS Run Screen</b> 	Opens the <b>ADCS Run Screen</b> .	4.3.5
<b>PG7601 Run Screen</b> 	Opens the <b>PG7601 Run Screen</b> .	4.3.6.1
<b>FPG Run Screen</b> 	Opens the <b>FPG8601 Run Screen</b> .	4.3.6.2
<b>PPC3 Pressure Controller Run Screen</b> 	Opens the FPG8601's <b>PPC3 Pressure Controller Run Screen</b> .	4.3.6.3
<b>RPM4 Pressure Monitor Run Screen</b> 	Opens the <b>RPM4 Pressure Monitor Run Screen</b> .	4.3.6.4
<b>Data Grid Run Screen</b> 	When a test is running, opens the <b>Data Grid Run Screen</b> .	4.4.3.2
<b>Data Plot Run Screen</b> 	When a test is running, opens the <b>Data Plot Run Screen</b> .	4.4.3.1

BUTTON	DESCRIPTION	SEE SECTION
<p><b>Create Data File</b></p> 	<p>When running a Manual Test, creates a new Data File. A standard windows filebox allows the selection of the Data File name and location. The choices in <b>[Options]</b>, <b>[Data File]</b> determine the default file naming convention and file location. It also specifies whether or not to automatically name the file and avoid the filebox prompt.</p> <p>A separate Data File is created for every active DUT. If there are no DUTs, only one Data File is created. However, no DUT information is logged.</p>	<p>4.4.2.1, 4.4.3.3</p>
<p><b>Log a single data point</b></p> 	<p>When running a Manual Test, if a data file has been created, logs the instantaneous output of all devices to the Data File. This is identical in function to using a 0 averaging time in a test. All non-automated devices must have their outputs entered in the &lt;Manual Data Entry &gt; window.</p>	<p>4.4.2.1, 4.4.3.3</p>
<p><b>Average and take 1 point</b></p> 	<p>When running a Manual Test, if a data file has been created, averages all devices according to the active averaging method. This is identical to averaging data during a test. Both automatic and manual averages can be used to average the data. The drop down arrow displays a menu that lists the automatic and manual averaging options. The option with an "*" preceding it is the active averaging mode.</p> <p>To change the automatic averaging time select it in the menu and enter the desired averaging time in the input box that follows. Data can be automatically averaged from 1 to 9999s.</p> 	<p>4.4.2.1, 4.4.3.3</p>
<p><b>Log 1 point at fixed intervals</b></p> 	<p>When running a Manual Test, if a data file has been created, logs an instantaneous data point at fixed time intervals. When the icon is pressed, an input box displays to allow entry of the time interval. A data point will automatically be logged when the option is pressed and data points will be logged repeatedly at the specified time interval until the <b>[Abort Data Acquisition]</b> button is pressed or the test is aborted. Taking data in this manner can be convenient when trying to monitor slowly evolving processes, e.g. the effect of temperature on a DUT.</p> <hr/> <p> <i>The output of all manual entry devices must be entered for every data point logged. This minimizes the automation provided by this function.</i></p> <hr/> <p> <i>Taking data at short time intervals can quickly result in a very large Data File.</i></p>	<p>4.4.2.1, 4.4.3.3</p>

BUTTON	DESCRIPTION	SEE SECTION
<p><b>Average and log points at fixed intervals</b></p> 	<p>When running a Manual Test, if a data file has been created, averages all device outputs and logs the results at fixed time intervals. When the icon is pressed the <b>&lt;Average Setup&gt;</b> window displays to allow entry of the averaging time and the interval between averages. After the entry, data automatically begins averaging. When the average is complete, the results are logged and the countdown to the next average begins. When the time specified as the <b>&lt;Timed Point Interval(s)&gt;</b> has been reached, another averaging cycle begins. This process is repeated until the <b>[Abort Data Acquisition]</b> button is pressed or the run mode is closed. Taking data in this way can be convenient when trying to mimic a test that includes multiple readings per point.</p> <hr/> <p> <i>Taking data at short time intervals can quickly result in a very large Data File.</i></p> <hr/> <p> <i>Press the <b>[Abort Data Acquisition]</b> option to abort fixed interval data acquisition.</i></p> <hr/> 	4.4.2.1, 4.4.3.3
<p><b>Abort data acquisition</b></p> 	<p>When running a Manual Test that is logging data, press this icon to abort data acquisition at fixed intervals or a point currently being averaged.</p>	4.4.3.3
<p><b>DUT/Reference Comparison Run Screen</b></p> 	<p>When a test is running, opens the <b>DUT/Reference Comparison Run Screen</b>. This display provides convenient, real time, error information calculated for each DUT compared to the ADCS-601-AF.</p>	4.4.3.3
<p><b>Device Run Screen</b></p> 	<p>When running an automated test, generates a popup menu to allow the selection of the desired Device Run Screen to display. The selected Device Run Screen automatically displays in the main window.</p> <hr/> <p> <i>Click outputs on the various run screens to get a list of options that apply to the output. Display unit of measure and resolution can be changed for most outputs.</i></p> <hr/>	4.4.2
<p><b>Step Back</b></p> 	<p>When running a Test Definition automated test, causes the current test point to be interrupted and the test point sequence to step back to the most recent target output step. Subsequent clicks cause the test to step back one point for each click. This button is used to repeat points when needed.</p>	4.4.2.2
<p><b>Step Forward</b></p> 	<p>When running a Test Definition automated test, causes the current test point to be interrupted and the test point sequence to step forward to the next step in the point sequence. This feature only moves forward up to the take data step of the highest point executed. The limitation is to ensure that data is logged at each point and points are not skipped entirely. Most often this button is used to skip through test dwell of an increment or to skip over previously executed points when the step back key has been used.</p>	4.4.2.2

### 4.3.4 ADCS STATUS BAR

The **ADCS Tools Status Bar** is located across the bottom of the main screen (see Figure 33, Figure 35).

In all run modes, **ADCS Tools** flashes information related to the status of its current operations on this display. The red panel on the left displays the current major function. The blue panel indicates the minor function, the text to the right indicates specific activity at a given moment.



Figure 35. ADCS Status Bar

### 4.3.5 ADCS RUN SCREEN

The **ADCS Tools ADCS Run Screen** should be considered the equivalent of an instrument front panel. It is the front panel of the ADCS-601-AF system. The run screen is the interface through which ADCS functions are controlled and readings are observed (see Figure 36).

The **ADCS Run Screen** is opened by pressing the **[ADCS Run Screen]** button on the **ADCS Main Toolbar**. The screen can be resized and repositioned.

The run screen has three main sections:

1. **Control Panel** (see Section 4.3.5.1): The **Control Panel** is for reading and controlling the ADCS-601-AF system. It includes instrument displays.
2. **System Display** (see Section 4.3.5.2): The **System Display** is to provide real time information on system status. It is an animated operational schematic of the ADCS-601-AF system.
3. **Toolbar** (see Section 4.3.5.3): The **Toolbar** buttons are for controlling ADCS-601-AF functions.

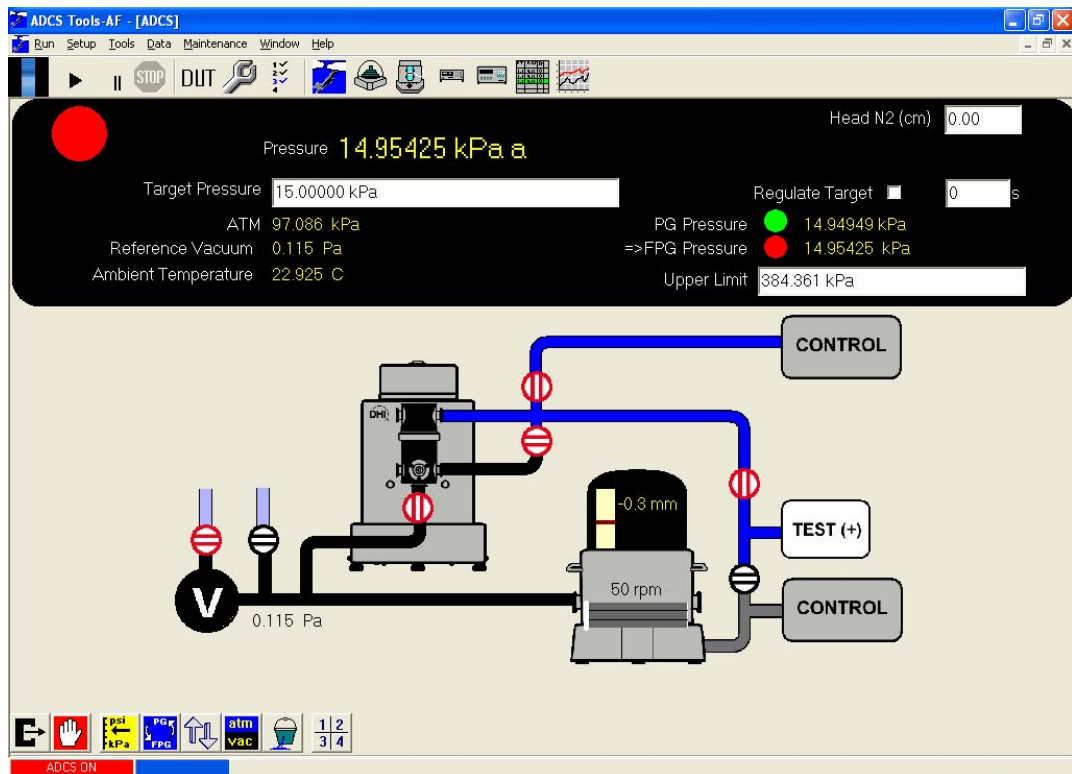


Figure 36. ADCS Run Screen

## 4.3.5.1 ADCS RUN SCREEN CONTROL PANEL

The features of the **ADCS Run Screen Control Panel** (see Figure 36) are summarized in Table 15.

**Table 15.** ADCS Run Screen Control Panel features

LABEL	DESCRIPTION
<b>Circular Ready/Not Ready Indicator and Ready timer</b>	<p>Green when the ADCS-601-AF pressure is <i>Ready</i>. Red when the pressure is <i>Not Ready</i>. When the FPG8601 is the active pressure standard, characters immediately below the circular indicator indicate whether the <i>Not Ready</i> condition is due to an FPG8601 operational limit being exceeded (see Section 4.1.1).</p> <p>When <i>Ready</i> is achieved, a counter is displayed to the upper right of the circular indicator. The counter accumulates time since the <i>Ready</i> condition occurred. This feature is convenient to assure a certain dwell time at pressure after the pressure has been set.</p>
<b>Pressure</b>	<p>Displays pressure, pressure unit of measure and measurement mode (&lt;a&gt; absolute, &lt;g&gt; gauge). This is the pressure applied to ADCS-601-AF <b>TEST(+)</b> port by the active pressure standard.</p> <p>When PG7601 is the active pressure standard, the pressure value shown is valid ONLY when the PG7601's piston is floating and the pressure is <i>Ready</i>.</p> <p>Provides a status message during functions in which the pressure is not known.</p> <p>Right click on the value to produces a pop up menu in which the unit of measure can be changed (see Section 4.2.2), the resolution of the pressure value can be adjusted and a strip chart of the value over time can be displayed.</p>
<b>Target Pressure</b>	<p>Enter/display a target pressure and the unit of measure. Double click the displayed value to highlight and edit the complete number.</p> <p>Enter a desired target pressure and press <b>[ENTER]</b> for the ADCS-601-AF to set a pressure automatically.</p>
<b>Regulate Target and [ ] s</b>	<p>Appear only when FPG8601 is the active pressure standard.</p> <p>Checking the <b>&lt;Regulate Target&gt;</b> box causes the FPG8601 system to regulate the pressure read by the FPG8601 to equal the target pressure value and changes the <i>Ready/Not Ready</i> criterion (see Sections 4.1.4, 4.1.2.3). This will cause the final set pressure to equal the target pressure and will increase the time required to set a pressure.</p> <p>The <b>&lt;s&gt;</b> value is the frequency, in seconds, with which the readjustment of pressure control to regulate to the target value occurs. Default is 30 s.</p>
<b>ATM</b>	<p>Displays atmospheric pressure value as read by the PG7601's on-board barometer.</p> <p>Right click on the value to produces a pop up menu in which the unit of measure can be changed, the resolution of the pressure value can be adjusted and a strip chart of the value over time can be displayed. The <b>&lt;ATM&gt;</b> unit of measure is independent of other pressure display fields.</p>
<b>Reference Vacuum</b>	<p>Displays current value of vacuum read by the CDG vacuum gauge of the active pressure standard when ADCS-601-AF is in absolute measurement mode.</p> <p>Indicates "N/A" when ADCS-601-AF is in gauge mode.</p> <p>Right click on the value to produces a pop up menu in which the unit of measure can be changed, the resolution of the pressure value can be adjusted and a strip chart of the value over time can be displayed. The <b>&lt;Reference Vacuum&gt;</b> unit of measure is independent of other pressure display fields.</p>

LABEL	DESCRIPTION
<b>Ambient Temperature</b>	<p>Current value of ambient temperature read by the active pressure standard. Value is from the PG7601 on-board temperature sensor when the PG7601 is active; the FPG8601 mounting post sensor when the FPG8601 is active.</p> <p>Right click on the value to produces a pop up menu in which the unit of measure can be changed, the resolution of the pressure value can be adjusted and a strip chart of the value over time can be displayed. Changing the <b>&lt;Ambient Temperature&gt;</b> unit of measure changes all <b>ADCS Tools</b> temperature displays.</p>
<b>Head Correction</b>	<p>Enter the difference in height between the reference level of the ADCS-601-AF system and the device under test, in centimeters [cm] (see Section 4.2.6). The value is positive if the DUT is above the ADCS reference level, negative if it is below.</p>
<b>PG Pressure (=&gt; when active standard)</b>	<p>Displays the current pressure and unit of measure or the status of the PG7601 pressure standard. The circular indicator is a <i>Ready/Not Ready</i> indicator (see Section 4.1.1).</p> <p>The pressure value shown is valid ONLY when the PG7601's piston is floating and the pressure is <i>Ready</i>.</p>
<b>FPG Pressure (=&gt; when active standard)</b>	<p>Displays the current pressure and unit of measure or the status of the FPG8601 pressure standard. The circular indicator is a <i>Ready/Not Ready</i> indicator (see Section 4.1.1).</p>
<b>Upper Limit</b>	<p>The maximum allowable target pressure for the ADCS-601-AF. This limit is imposed for all test and manually entered target pressures.</p> <p>Change the limit by entering a new maximum pressure value in the current ADCS-601-AF unit of measure. The minimum allowable entry value is 110 kPa (32.5 inHg). The maximum allowable entry value cannot exceed 384 kPa (113.4 inHg).</p> <p>The PG7601 pressure controller Upper Limit setting is forced to 110% of the <b>&lt;Upper Limit&gt;</b> entry. Review the PPC3 Operation and Maintenance Manual for details on the Upper Limit setting of a PPC3.</p> <p>Since the PG7601 can only set a target pressure within approximately 1 kPa (0.3 inHg) of the requested target, it is possible for an ADCS-601-AF pressure to exceed the <b>&lt;Upper Limit&gt;</b> entry by approximately 1 kPa (0.3 inHg).</p>


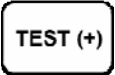

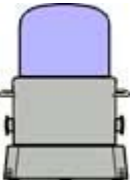

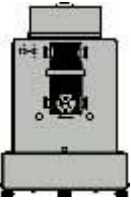

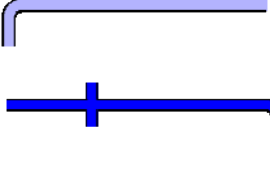
#### 4.3.5.2 ADCS SYSTEM DISPLAY

The **ADCS System Display** is a simplified operational schematic of the ADCS-601-AF system that provides the operator with real time, quick visual indication of ADCS-601-AF system states (see Figure 37). The schematic represents the FPG8601 and PG7601 pressure standards, their pressure controllers and the measured pressure and reference pressure circuits with valves.

Table 16 summarizes the symbols used in the **ADCS System Display**.



Table 16. ADCS System Display symbols

FEATURE	DESCRIPTION
<b>Vacuum Pump</b> 	Represents the reference vacuum pumping system. <ul style="list-style-type: none"> <li>- White &lt;V&gt; on black background = vacuum pump is ON and pulling a vacuum.</li> <li>- Black &lt;V&gt; on white background = vacuum pump is OFF.</li> </ul>
<b>TEST(+) port</b> 	<b>TEST(+)</b> port on front of Reference Bench to which ADCS-601-AF sets pressures and device under test is connected. Changes to <MONITOR> when running an FPG Validation.
<b>Pressure Controller</b> 	PG7601 and FPG8601's pressure controllers. To view the pressure measured by the controller's internal transducer, see the controller component's front panel (in the Control Cabinet).
<b>PG7601 Pressure Standard</b> 	PG7601 gas operated piston gauge (see Section 2.2.1). The PG7601 piston position is represented graphically and digitally in the bell jar area and the mass rotation is represented in the AMH vacuum chamber area. <ul style="list-style-type: none"> <li>- Bell jar light blue = ADCS-601-AF is in gauge measurement mode; atmospheric pressure is under the bell jar.</li> <li>- Bell jar black = ADCS-601-AF is in absolute measurement mode; vacuum is under the bell jar.</li> </ul>
<b>PG7601 masses</b> 	PG7601 masses. White vertical line movement approximates mass rotation rate.
<b>FPG8601 Pressure Standard</b> 	FPG8601 force balanced piston gauge (see Section 2.2.2).
<b>Automated Valve</b> 	Control valve. <ul style="list-style-type: none"> <li>- Vertical parallel lines = valve open</li> <li>- Horizontal parallel lines = valve closed</li> <li>- Black = valve not actuated/energized</li> <li>- Red = valve actuated/energized</li> </ul>
<b>Pressure tubing</b> 	Tubes making up measured pressure, reference pressure and control pressure circuits. <ul style="list-style-type: none"> <li>- Light blue = at atmospheric pressure, vented (valid for all circuits).</li> <li>- Dark blue = under control of active pressure standard system (PG7601 or FPG8601).</li> <li>- Black = under reference vacuum.</li> <li>- Grey = Unknown status.</li> </ul>

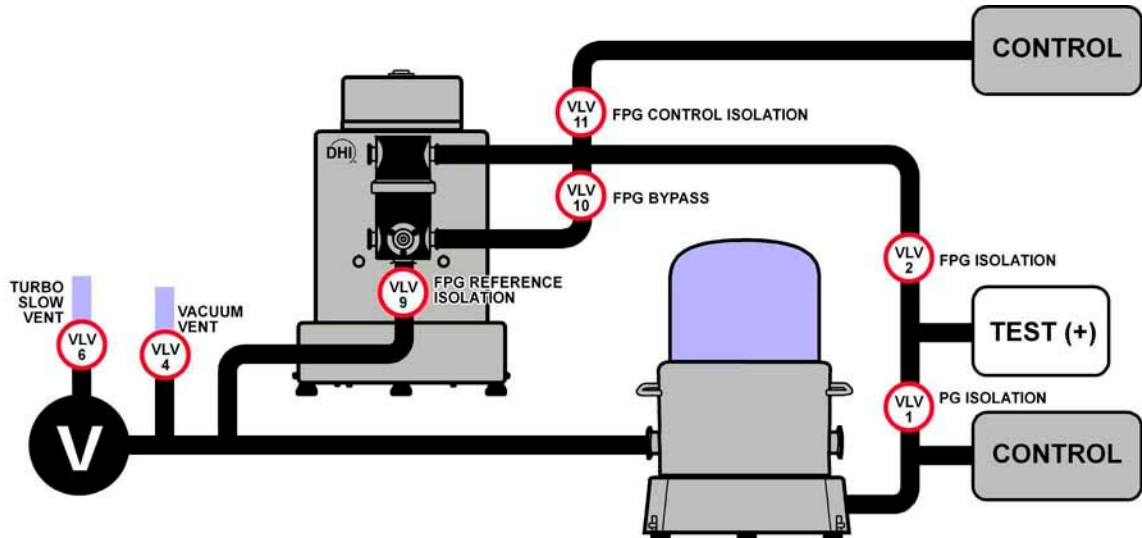










Figure 37. ADCS System Display

### 4.3.5.3 ADCS RUN SCREEN TOOLBAR

The **ADCS Run Screen Toolbar** is at the bottom of the **ADCS Run Screen**. Its buttons are summarized in Table 17.

Table 17. ADCS Run Screen Toolbar

BUTTON	DESCRIPTION
<p><b>Vent</b></p> 	<p>Causes ADCS-601-AF to vent the <b>TEST(+)</b> port to atmosphere (see Section 4.2.4.2).</p> <p>Always makes PG6701 the active pressure standard and vents unless the <b>&lt;Use the FPG measurement when vented in gauge mode&gt;</b> option is active (see Section 4.2.4.1).</p>
<p><b>Abort Control</b></p> 	<p>Aborts on-going pressure control. When the FPG8601 is the active pressure standard, the pressure will continue to increase until a new target pressure is set or the <b>[Vent]</b> button is pressed. The increase in pressure is a direct result of the lubrication flow in the FPG8601.</p> <hr/> <p> <i>Always vent or set a new target pressure after aborting pressure control when the FPG8601 is the active pressure standard. Failure to do so will eventually result in an FPG8601 overpressure condition. ADCS Tools automatically vents all system pressure after an FPG8601 overpressure.</i></p>
<p><b>Change Pressure Unit of Measure</b></p> 	<p>Changes pressure unit of measure for all ADCS-601-AF pressure values other than atmospheric pressure and reference vacuum.</p> <p>Click any displayed quantity on any ADCS-601-AF run screen to access a popup menu with a choice to change the unit of measure.</p>
<p><b>Change Active Pressure Standard</b></p> 	<p>Transition active pressure standard from PG7601 to FPG8601 or vice-versa (see Section 4.1.3).</p> <p>Since ADCS-601-AF automatically transitions pressure standards as needed depending upon the target pressure request, this function is not frequently used in normal operation.</p>
<p><b>Exercise</b></p> 	<p>Setup and run an automated routine to cycle pressure a given number of times between a minimum and maximum value (see Section 4.2.5).</p>

BUTTON	DESCRIPTION
<p><b>Change Unit of Measure</b></p> 	<p>Change measurement mode (gauge to absolute and vice-versa) (see Section 4.2.3).</p> <p>Press the down arrow to change the measurement mode, press the button itself to reset the current measurement mode.</p>
<p><b>Leak Test</b></p> 	<p>Run an ADCS-601-AF pressure leak test (see Section 4.2.9). The leak test can be used in absolute measurement mode only.</p>

## 4.3.6 OTHER DEVICE RUN SCREENS

### 4.3.6.1 PG7601 PRESSURE STANDARD

The **PG7601 Run Screen** provides more detailed information on PG7601 status and a **Toolbar** to control it directly. Use the **[PG7601 Run Screen]** button on the **ADCS Tools Main Toolbar** to open the screen. The screen may be resized and relocated.



*The PG7601 Run Screen should only be used to view PG7601 status. Use of the Toolbar on this run screen may conflict with other ADCS-601-AF Tools functions. The PG7601 Run Screen Toolbar should only be used for advanced trouble shooting by qualified personnel.*

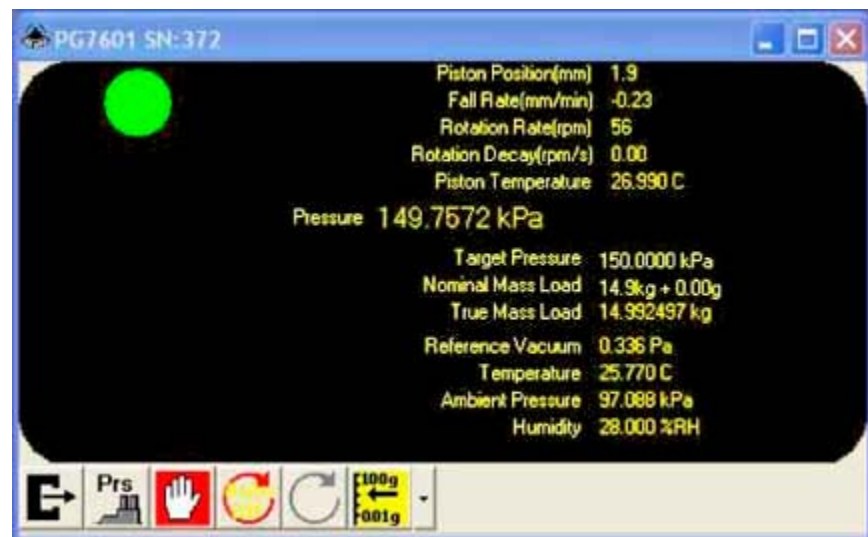


Figure 38. PG7601 Run Screen

#### 4.3.6.2 FPG8601 PRESSURE STANDARD

The **FPG8601 Run Screen** provides more detailed information on FPG8601 status and a **Toolbar** to control it directly. Use the [**FPG8601 Run Screen**] button on the **ADCS Tools Main Toolbar** to open the screen. The screen may be resized and relocated.



The FPG8601 Run Screen should only be used to view FPG8601 status. Use of the Toolbar on this run screen may conflict with other ADCS-601-AF Tools functions. The FPG8601 Run Screen Toolbar should only be used during ADCS-601-AF start up or for advanced trouble shooting by qualified personnel.



Figure 39. FPG8601 Run Screen

#### 4.3.6.3 PPC3 (FPG'S PRESSURE CONTROLLER)

The **PPC3 Run Screen** provides more detailed information on the FPG8601 system's pressure controller and a **Toolbar** to control it directly. Use the [**PPC3 Run Screen**] button on the **ADCS Tools Main Toolbar** to open the screen. The screen may be resized and relocated.



The PPC3 Run Screen should only be used to view PPC3 status. Use of the Toolbar on this run screen may conflict with other ADCS-601-AF Tools functions. The PPC3 Run Screen Toolbar should only be used for advanced trouble shooting by qualified personnel.



There is no PPC3 Run Screen for the PG7601 system's PPC3 pressure controller because the PG7601 PPC3 is controlled by the PG7601, not by ADCS Tools.



Figure 40. PPC3 Run Screen

#### 4.3.6.4 RPM4 REFERENCE PRESSURE MONITOR

The **RPM4 Run Screen** provides more detailed information on the RPM4's pressure controller and a **Toolbar** to control it directly. Use the **[RPM4 Run Screen]** button on the **ADCS Tools Main Toolbar** to open the screen. The screen may be resized and relocated.



*The RPM4 Run Screen should only be used to view RPM4 status. Use of the Toolbar on this run screen may conflict with other ADCS-601-AF Tools functions. The RPM4 Run Screen Toolbar should only be used for advanced trouble shooting by qualified personnel.*



Figure 41. RPM4 Run Screen

## 4.4 AUTOMATED TESTING

---



ADCS Tools uses the engine of COMPASS for Pressure® calibration software to manage automated testing using ADCS-601-AF. Frequent reference is made to the COMPASS for Pressure User's manual for detail on setting up and running automated tests that is beyond the scope of this manual. The COMPASS for Pressure manual is an on-line manual available by pressing the [?] button, when available, in COMPASS features. It can also be accessed on the ADCS-601-AF system controller in the COMPASS for Pressure program group reached using the Windows START button , Programs.

---

ADCS-601-AF has the capability to run automated tests. Automated tests are tests in which a device under test (DUT) is defined and test data is logged to a data file. If the DUT is able to be interfaced with ADCS-601-AF by an RS232, IEEE-488 or USB interface, readings can be acquired from it automatically during the test.

Two test run modes are available. **[Run Manual Test]** runs a point by point test controlled by the operator. **[Run Test Definition]** runs a multi-point test script on a device under test (DUT). Running a test definition with a DUT whose output can be interfaced with ADCS-601-AF allows a complete test sequence to be run unattended by an operator.

See Section 4.4.1 for information on **setting up** to run automated tests.

See Section 4.4.2 for information on **running** automated tests.

---



ADCS Tools is preconfigured to support automated validation (calibration) and standardization of the King Nutronics 3682 Air Data Calibrator (see Section 4.4.6).

---

### 4.4.1 SETTING UP TO RUN AUTOMATED TESTS

To run an automated test, a DUT Definition must be setup to identify the device under test (see Section 4.4.1.1). To run a multipoint test following a scripted test scenario, a Test Definition must also be set up (see Section 4.4.1.2). If support devices that are not part of the ADCS-601-AF such as a multimeter or a temperature chamber are needed to run a test, Support Device Definitions must be set up to define them (see Section 4.4.1.3).

#### 4.4.1.1 SETTING UP DEVICE UNDER TEST (DUT)

---



ADCS Tools uses the engine of COMPASS for Pressure® calibration software to manage automated testing using ADCS-601-AF. The DUT Editor is a COMPASS for Pressure Device Editor. See the COMPASS for Pressure User's Manual for complete information on Device Editors and DUT Definitions. The COMPASS for Pressure manual is an on-line manual available by pressing the [?] button, when available, in COMPASS features. It can also be accessed on the ADCS-601-AF system controller in the COMPASS for Pressure program group reached using the Windows START button , Programs.

---

**ADCS Tools** automated testing is organized around the support, testing and maintenance of Devices Under Test (DUTs). DUT Definitions not only specify the relationship between raw device outputs and pressure; they determine how the output data will be acquired and maintain calibration and tracking information

for the device. A DUT can be setup to provide DUT pressure only or to include measurement of other variables.

The DUT Editor provides features to create, edit, view and remove DUT Definitions from the **ADCS Tools** database. Access the DUT Editor by pressing **[Setup], [DUT]** from the **ADCS Tools** main menu or pressing the **[DUT Editor]** button on the main toolbar. When selected, the last accessed DUT Definition displays. To edit an existing DUT, use the **Editor Toolbar** features to select the desired DUT. Then simply edit the desired fields. Press the **Editor Toolbar, [Save]** button to save the changes.

Sample DUTs are already included in the DUT Definition database as examples.

Use the following steps to create a DUT Definition.

- ❶ Select **[Setup], [DUT]**
- ❷ Press the Editor Toolbar, **[New]** button.
- ❸ Enter a **<Record Label>** that allows users to quickly identify the defined DUT.
- ❹ Begin completing the DUT Definition starting with the **[Header]** tab. Select a **<DUT Type>** and a **<Record Type>**.



*DUTs can be defined as <Individual>, <Profile> and <Profile w/Range>. These selections allow an explicit DUT to be created including specific range and serial number information; or, a profile DUT that is identified during the test initialization process. Profile DUTs allow one DUT Definition to represent any number of like <Model> devices from the same <Manufacturer>.*

- ❺ Select the **<Manufacturer>** and **<Model>** on the **[Header]** tab. If the desired selections are in the drop down list, press the **[Find Previous Setup]** button to search for previous setups or examples of the DUT. If the **<Manufacturer>** and **<Model>** are not in the list, enter them.
- ❻ Enter relevant information on the **[Calibration]** tab.
- ❼ Select the appropriate **<Data Acquisition Type>** and corresponding settings using the **[Communications]** tab.
- ❽ If applicable, select the **[Output]** tab. Simple DUTs allow direct entry of all relevant final output information. To create a final output for advanced DUTs, press the **[Add]** button and edit the information on the Output Relationship Editor. If the final output requires remote commands to read the **<Raw Output>**, press the **[Edit Commands]** button to launch the Remote Command Editor. Simple DUT remote commands are accessed on the **[Communications]** tab. Specify the commands required to interface with the device. Press the **[Add]** button to add as many final outputs as are supported by the DUT.
- ❾ The **[Set]** tab is used when the DUT will be used as a controller. However, the DUT cannot be used as a controller in **ADCS Tools**.
- ❿ Press the Editor Toolbar, **[Save]** button to save all changes. Any errors in the setup must be remedied before the DUT Definition can be saved.



#### 4.4.1.2 SETTING UP TEST DEFINITIONS

---



ADCS Tools uses the engine of COMPASS for Pressure® calibration software to manage automated testing using ADCS-601-AF. The Test Editor is a COMPASS for Pressure feature. See the COMPASS for Pressure User's Manual for complete information on Test Editor. The COMPASS for Pressure manual is an on-line manual available by pressing the [?] button, when available, in COMPASS features. It can also be accessed on the ADCS-601-AF system controller in the COMPASS for Pressure program group reached using the Windows START button , Programs.

---

Test Definitions are used to define a specific test procedure including the sequence of test points and a large number of operational details. DUT(s) to be tested and a Test Definition are selected during the initialization of **ADCS Tools**, **[Run Test Definition]** mode. A pointer to a default Test Definition for a DUT is included in the DUT Definition, **[Calibration]** tab.

Create, edit and remove Test Definitions using the Test Editor. Access this feature using the **ADCS Tools [Setup], [Test]** or the Main Toolbar, **[Edit Test]** button. When the Test Editor is opened, the last accessed Test Definition is displayed. While in the Editor, use the Editor Toolbar options to create, edit, view and delete tests.

Sample tests are already included in the Test Definition database as examples.

The Test Editor uses the same editing concepts as the DUT Editor. Only one Test Definition can be edited at a time. The test scroll bar and the Test Selector are available to make new test selections. A flashing indicator displays when a Test Definition is modified or a new definition is created.

---



Familiarity with test execution sequence is necessary for proper setup of a Test Definition. Review Section 4.4.2.1 before setting up a Test Definition.

---

Tests can be edited whenever **ADCS Tools** is not in an active run mode. Select **[Setup], [Test]** to display the Test Editor. Simply changing information in the Test Editor places the Editor in the edit mode. No specific option needs be selected to begin editing a Test Definition. Use the **[Save]** button to store the edits or press the **[Restore]** button to return the test to its original state.

Different types of Test Definitions are supported. The choices are:

- **Simple Test** – Basic test that defines a list of pressure points only. No macro or changes in reference device during the test are permitted.
  - **Advanced Test** – Can include temperature points. In addition Test Macros can be used to test a device.
- 



When setting up Test Definitions in ADCS Tools the pressure <Read> and <Set> device is always <ADCS-601> and cannot be changed.

---



---

### 4.4.1.3 SETTING UP SUPPORT DEVICES

---



ADCS Tools uses the engine of COMPASS for Pressure<sup>®</sup> calibration software to manage automated testing using ADCS-601-AF. The Support Device Editor is a COMPASS for Pressure Device Editor. See the COMPASS for Pressure User's Manual for complete information on Device Editors and Support Device Definitions. The COMPASS for Pressure manual is an on-line manual available by pressing the [?] button, when available, in COMPASS features. It can also be accessed on the ADCS-601-AF system controller in the COMPASS for Pressure program group reached using the Windows START button, Programs.

---

All devices that are not specifically DUTs are considered support devices. Support devices are setup in Support Device Definitions using the Support Device Definition Editor. Device Definitions define support devices that measure and produce outputs as well as devices that control in response to target sets. A Support Device Definition can also allow the device to act as a DUT to allow it to be tested and calibrated without having to set it up separately as a DUT. A single support device can provide multiple final outputs and final sets.

The Support Device Editor provides features to create, edit, view and remove Support Device Definitions from the **ADCS Tools** database. Access the Support Device Editor by pressing **[Setup]**, **[Support Device]** or the **Main Toolbar [Device Definition Editor]** button. When selected, the last accessed Support Device Definition displays. To edit an existing Support Device Definition, use the Editor Toolbar buttons to select the desired definition. Then simply edit the desired fields. Press the **Editor Toolbar, [Save]** button to save the changes.

Sample Support Devices are already included in the Support Device database as examples.

### 4.4.1.4 TEST OPTIONS (DATA OPTIONS)

---



ADCS Tools uses the engine of COMPASS for Pressure<sup>®</sup> calibration software to manage automated testing using ADCS-601-AF. The Test Options supported by ADCS Tools are COMPASS for Pressure features. See the COMPASS for Pressure User's Manual section on [Tools], [Options] for complete information on ADCS Tools Test Options tabs. The COMPASS for Pressure manual is an on-line manual available by pressing the [?] button, when available, in COMPASS features. It can also be accessed on the ADCS-601-AF system controller in the COMPASS for Pressure program group reached using the Windows START button , Programs.

---

**ADCS Tools** allows preferences to be set concerning how data is collected and displayed when running automated tests and operations that occur to conclude a test. These preferences are set using **[Tools]**, **[Test Options]**.

The **[Test Options]** form includes five tabs whose functions are describe below.

#### **[Data Grid] Tab**

The **[Data Grid]** tab is used to customize the **Data Grid Run Screen** that is available while running tests. The grid can be customized to display only the desired data field columns while suppressing other columns. The order of the columns can also be changed. Any test data item logged in the Data File can be included in any column of the **Data Grid Run Screen** by using the correct

combination of features. Press the **[Default Settings]** button to automatically display the **ADCS Tools** default data fields.

#### **[Data File] Tab**

The **[Data File]** tab is used to customize the selection of data fields that are actually logged in the test Data File. The selections do not affect the data displayed in the **Data Grid Run Screen**. Although a specific piece of data is not logged in a test Data File, it can still display in the **Data Grid Run Screen**. Only data actually logged to the Data File can be imported into the Test Data Database. Press the **[Default Settings]** button to automatically log the **ADCS Tools** default data fields.

#### **[Data Header] Tab**

The **[Data Header]** tab is used to customize the data logged in the header portion of a test Data File. Header data includes detailed information on the specific devices used to measure test data. Although header data is the basis of report information, not all header data is desired. Few **ADCS Tools** setups will require all header data. Check the header options relevant to your typical setups.

#### **[End Test] Tab**

The **[End Test]** tab is used to user preferences affecting operations that occur to conclude a test sequence.

**<Finish point of each cycle>** allows the operator to use the **ADCS Tools** features to step back in a test to repeat points. Check **<Enable repeat for fixed time delay>** and enter a time to allow stepping back for a fixed time after the test ends. Check **<Prompt to repeat>** to have **ADCS Tools** query the operator at the end of a test. Check **<No repeat option>** to have the test complete without pausing.

Check **<Auto generate reports after complete test>** to have **ADCS Tools** automatically generate a test report using the last report template used when the test is completed. The **<Test Complete>** options still display at the end of the test.

Check **<Prompt for test notes at the end of complete tests>** to have **ADCS Tools** prompt the operator to enter notes specific to the test once the test has completed.

## 4.4.2 RUNNING AUTOMATED TESTS

---



*ADCS Tools uses the engine of COMPASS for Pressure® calibration software to manage automated testing using ADCS-601-AF. The Run Test functions supported by ADCS Tools are COMPASS for Pressure features. See the COMPASS for Pressure User's Manual Run Modes Section for complete information on running automated tests. The COMPASS for Pressure manual is an on-line manual available by pressing the [?] button, when available, in COMPASS features. It can also be accessed on the ADCS-601-AF system controller in the COMPASS for Pressure program group reached using the Windows START button, Programs.*

---

**ADCS Tools** has two automated test run modes. In both run modes, a data file is created to collect data from the test.

**Run Test Definition** Activated by selecting **[Run]**, **[Run Test Definition]** from the **ADCS Tools** main run menu. This run mode is to run a Test Definition that specifies a pre-defined test sequence and test parameters.

**Run Manual Test** Activated by selecting **[Run]**, **[Run Manual Test]** from the **ADCS Tools** main run menu. This run mode allows any combination of test hardware and DUTs to be specified. There is no pre-defined test sequence. Pressures can be set as desired and data can be taken at any time by pressing the appropriate data acquisition option on the **Main Toolbar**.

Before activating a run mode, make sure that all instruments that will be used to run are properly configured and remotely connected to the system controller (host PC). This will prevent interface time-outs that will interrupt the test initialization process.

#### 4.4.2.1 RUNNING A MANUAL TEST



*ADCS Tools uses the engine of COMPASS for Pressure® calibration software to manage automated testing using ADCS-601-AF. The Run Manual Test function supported by ADCS Tools is a COMPASS for Pressure feature. See the COMPASS for Pressure User's Manual Run Modes Section for complete information on running automated tests. The COMPASS for Pressure manual is an on-line manual available by pressing the [?] button, when available, in COMPASS features. It can also be accessed on the ADCS-601-AF system controller in the COMPASS for Pressure program group reached using the Windows START button , Programs.*

Use this feature to manually select a DUT and support devices to include in a test and execute the test without predefined parameters in a Test Definition. This run mode is useful for running devices when there is no fixed sequence to be executed. Although, data acquisition is supported, it is not a required part of a Manual Test. During the test initialization process, the last Manual Test selections display. These selections can be changed if desired. There are no requirements to use any specific combination of devices. For example, a Manual Test can be executed using a temperature controller only. Manual Tests should be used for trouble shooting device final output setups and running specialized tests. Run a Manual Test, for example, to verify that a device is working properly with **ADCS Tools** or to log "drift" data of a device over time at one point.

To run a Manual Test select **[Run]**, **[Run Manual Test]**. Test Initialization occurs in the same manner as when running a Test Definition but no Test Definition selection is required (see Section 4.4.2.2). After initialization, all remote devices are automatically polled and output information is displayed on their respective run screens. Use the features on the Data Acquisition section of the Main Toolbar to create a Data File and log test points. Use features on the **Test Conditions Run Screen** as well as the individual run screens of the devices to change the state of the devices.

#### 4.4.2.2 RUNNING A TEST DEFINITION



*ADCS Tools uses the engine of COMPASS for Pressure® calibration software to manage automated testing using ADCS-601-AF. The Run Test Definition function supported by ADCS Tools is a COMPASS for Pressure feature. See the COMPASS for Pressure User's Manual Run Modes Section for complete information on running automated tests. The COMPASS for Pressure manual is an on-line manual available by pressing the [?] button, when available, in COMPASS features. It can also be accessed on the ADCS-601-AF system controller in the COMPASS for Pressure program group reached using the Windows START button , Programs.*

A Test Definition test has the test parameters and pressure sequence pre-defined (see Section 4.4.1). To run a Test Definition test, a DUT Definition and Test Definition must have been created (see Section 4.4.1.1, 4.4.1.2).

To run a Test Definition select **[Run]**, **[Run Test Definition]**. The run process has three main steps:

- ❶ **Test Initialization:** Steps through screens to:
  - Select unit of measure. When running a Test Definition, the unit specified by the Test Definition is always used to log data.
  - Specify user.
  - Select DUT(s) to be tested. Double click DUTs in the grid to add them to the list of DUTs to be tested.
  - Configure DUT(s). Specifies details specific to the DUT being tested.
  - Select Test Definition to be run. By default, the Test Definition specified in the DUT Definition is selected. Double click the desired Test Definition.
  - After the Test Definition has been selected, most ADCS-601-AF users can press **[Finish]** to skip remaining initialization steps and go directly to running the test.
- ❷ **Run Test Sequence:** Runs leak test (if included) and pressure exercise (if included) followed by the test points taking data at each point based on the test data selections. The test parameters are defined by the Test Definition (see Section 4.4.1.2).
- ❸ **End Test:** Presents the Test Notes screen to record test specific notes and the Test Complete screen with various test conclusion options. Certain aspects of the test conclusion can be customized using the **[Tools]**, **[Test Options]**, **[End Test]** tab (see Section 4.4.1.4).

### 4.4.3 TEST RUN SCREENS

Special run screens are available when running an automated test.

The **Data Plot** and **Data Grid Run Screens** are available when running any automated test for which there is a data file. These run screens visualize test results while the test is running.

The **DUT/Reference Comparison Run Screen** is available when running any automated test, regardless of whether there is a data file. This screen provides real time DUT and ADCS-601-AF readings and information on the agreement between them.

See Section 4.4.3.1 for information on the **Data Plot Run Screen**, Section 4.4.3.2 for information on the **Data Grid Run Screen** and Section 4.4.3.3 for information on the **DUT/Reference Comparison Run Screen**.

### 4.4.3.1 DATA PLOT RUN SCREEN



ADCS Tools uses the engine of COMPASS for Pressure® calibration software to manage automated testing using ADCS-601-AF. The Data Plot Run Screen supported by ADCS Tools is a COMPASS for Pressure feature. See the COMPASS for Pressure User's Manual for additional information on this screen and its options. The COMPASS for Pressure manual is an on-line manual available by pressing the [?] button, when available, in COMPASS features. It can also be accessed on the ADCS-601-AF system controller in the COMPASS for Pressure program group reached using the Windows START button, Programs.

The **Data Plot Run Screen** is available any time a test is running for which there is a data file. The screen can be used to display a variety of graphs of the data currently logged in the Data File.

The **Data Plot Run Screen** can be opened by pressing the **[Data Plot]** button on the **ADCS Tools Main Tool Bar** (see Section 4.3.3, Table 14).

Each point taken during a test causes the graph to update with the current test point information. The graph can be changed or printed without affecting test execution. Use the **Data Plot Tool Bar** on the **Data Plot Run Screen** to select the plot type and customize the current view.

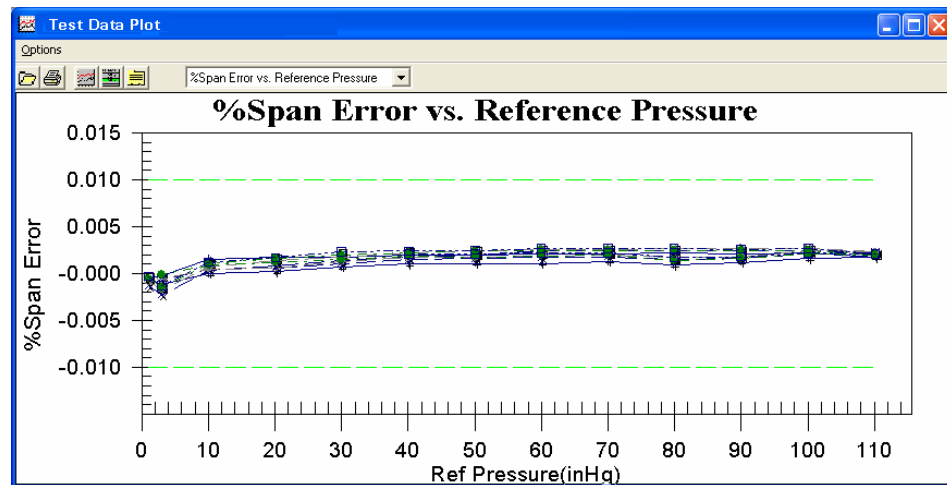


Figure 42. Data Plot Run Screen

### 4.4.3.2 DATA GRID RUN SCREEN



ADCS Tools uses the engine of COMPASS for Pressure® calibration software to manage automated testing using ADCS-601-AF. The Data Grid Run Screen supported by ADCS Tools is a COMPASS for Pressure feature. See the COMPASS for Pressure User's Manual for additional information on this screen and its options. The COMPASS for Pressure manual is an on-line manual available by pressing the [?] button, when available, in COMPASS features. It can also be accessed on the ADCS-601-AF system controller in the COMPASS for Pressure program group reached using the Windows START button, Programs.

The **Data Grid Run Screen** is available any time a test is running for which there is a Data File. The screen visualizes the data taken during the test, point by point in columns.

The **Data Grid Run Screen** can be opened by pressing the **[Data Grid]** button on the **ADCS Tools Main Tool Bar** (see Section 4.3.3, Table 14).

The contents of the **Data Grid Run Screen** can be customized using the **[Data Grid]** tab of **[Tools]**, **[Test Options]** (see Section 4.4.1.4).

Point	Ref Final Output (inHg)	DUT Final Output (inHg)	DUT Raw Out1 (inHg)	Tolerance (inHg)	Span Error (%)	Rdg Error (%)
1.1	1.0028	1.0023	1.0023	0.0110	-0.0005	-0.0499
1.2	3.0029	3.0027	3.0027	0.0110	-0.0002	-0.0067
1.3	10.0493	10.0509	10.0509	0.0110	0.0015	0.0159
1.4	20.0942	20.0961	20.0961	0.0110	0.0017	0.0096
1.5	29.9499	29.9518	29.9518	0.0110	0.0017	0.0063
1.6	40.0669	40.0691	40.0691	0.0110	0.0020	0.0055
1.7	50.1119	50.1141	50.1141	0.0110	0.0020	0.0044
1.8	59.9740	59.9763	59.9763	0.0110	0.0021	0.0036
1.9	70.0222	70.0245	70.0245	0.0110	0.0021	0.0033
1.10	79.8910	79.8934	79.8934	0.0110	0.0022	0.0030
1.11	89.9381	89.9404	89.9404	0.0110	0.0021	0.0026
1.12	100.0780	100.0774	100.0774	0.0110	0.0022	0.0024
1.13	110.1197	110.1216	110.1216	0.0110	0.0017	0.0017
1.14	100.0747	100.0765	100.0765	0.0110	0.0014	0.0018

Figure 43. Data Grid Run Screen

#### 4.4.3.3 DUT/REFERENCE COMPARISON RUN SCREEN



ADCS Tools uses the engine of COMPASS for Pressure calibration software to manage automated testing using ADCS-601-AF. The DUT/Reference Comparison Run Screen supported by ADCS Tools is a COMPASS for Pressure feature. See the COMPASS for Pressure User's Manual for additional information on this screen and its options. The COMPASS for Pressure manual is an on-line manual available by pressing the [?] button, when available, in COMPASS features. It can also be accessed on the ADCS-601-AF system controller in the COMPASS for Pressure program group reached using the Windows START button, Programs.

The **Reference/DUT Comparison Run Screen** is available any time a test is running. The screen visualizes real time DUT and ADCS-601-AF readings and the error of the DUT(s) compared to the ADCS-601-AF. The information on the display is organized into rows and columns. The columns separate different pieces of information. The rows separate the different devices. The first row is a label that describes the output. The second row is always the ADCS-601-AF output information. All subsequent rows are for the number of DUTs in use..

The **Reference/DUT Comparison Run Screen** can be opened by pressing the **[Reference/DUT Comparison]** button on the **ADCS Tools Main Tool Bar** (see Section 4.3.3, Table 14).

Device	Output	1Rd Err	1Rdg Err	Tol
ADCS-601-AF/ID:ADCE Station 1.00000	inHg			
3682/SN:101	1.0023 inHg	0.007	0.230	0.0026 inHg

Figure 44. DUT/Reference Comparison Run Screen

#### 4.4.4 TEST DATA



ADCS Tools uses the engine of COMPASS for Pressure® calibration software to manage automated testing using ADCS-601-AF. The ADCS Tools Data File and Database structure, protocol and features are COMPASS for Pressure feature. See the COMPASS for Pressure User's Manual for additional information on Data Files and the Database. The COMPASS for Pressure manual is an on-line manual available by pressing the [?] button, when available, in COMPASS features. It can also be accessed on the ADCS-601-AF system controller in the COMPASS for Pressure program group reached using the Windows START button , Programs.

When **ADCS Tools** runs a test, it logs exhaustive test related data in a Data File (\*.dat). The Data File is automatically generated and stored to a DUT dependent directory. Data Files can be viewed as raw text in almost any text editor or spreadsheet application. Using the ADCS Tools Report Editor (see Section 4.4.5), Data Files can be merged with report templates to generate custom test reports.

Data Files are stored in directories based on the path options select in **[Tools]**, **[Test Options]**, **[Data File]**. The default path is C:\Program Files\COMPASS for Pressure\Data\DUT Manufacturer\DUT SN (see Section 4.4.1.4).

Use **[Data]**, **[Data File Viewer]** to view the contents of a Data File using the ADCS Tools Data file viewer. Select the Data File to view. Use the Data File Viewer Toolbar to select a new file to view, print the data, hide the data grid or plot the data.

Use **[Data]**, **[Plot Data File]** to plot the contents of data files. Select the Data File to be plotted. Use the Plot **[Options]**, and drop down plot type selector to modify the plot.

The data in a test Data File can also be stored in the Test Data Database. The database is in the Microsoft Access format. This common format enables easy manipulation and integration with other databases. Users are welcome to add fields and customize the database as desired. However, if the fundamental structure of the database is altered, the Database Data Viewer will no longer work properly.

Test data is not automatically added to the Test Data Database. It can be added to the Database by selection when a test is completed (see Section 4.4.2.2). Data from an existing test Data File can also be added to the Database using **[Data]**, **[Write Data File to Database]**.

To view the Test Data Database and use Database functions, select **[Data]**, **[Database Data Viewer]**.

#### 4.4.5 REPORT EDITOR



ADCS Tools uses the engine of COMPASS for Pressure® calibration software to manage automated testing using ADCS-601-AF. The ADCS Tools Report Editor is a COMPASS for Pressure feature. See the COMPASS for Pressure User's Manual for additional information on the Report Editor. The COMPASS for Pressure manual is an on-line manual available by pressing the [?] button, when available, in COMPASS features. It can also be accessed on the ADCS-601-AF system controller in the COMPASS for Pressure program group reached using the Windows START button , Programs.

The **ADCS Tools** Report Editor is used to generate reports from \*.dat files and/or data stored in the Test Data Database. The Report Editor provides the features to create, view and edit reports and templates. The Report Editor is essentially a customized word processor and as such, navigation and use is intuitive to users familiar with commonly used word processors. During the report generation process, user defined templates are merged with Data Files to



create final reports. These newly generated reports may be saved as Microsoft Word documents or PDF documents if Adobe Acrobat is installed.

The Report Editor is accessed by: selecting **[Data]**, **[Report Editor]** from the **ADCS Tools Main Menu** or pressing the **[Generate Report]** button in the Test Complete form at the end of a test. In all cases the Report Editor runs as a separate application and may be closed at any time without affecting the operation of **ADCS Tools**.

## 4.4.6 RUNNING A MODEL 3682 AIR DATA CALIBRATOR

**ADCS Tools** is preconfigured to support automated validation (calibration) and standardization of the King Nutronics 3682 Air Data Calibrator.

See Section 4.4.6.1 to validate (calibrate) the model 3682. See Section 4.4.6.2 to standardize the model 3682.

### 4.4.6.1 RUNNING A VALIDATION (CALIBRATION)

---



*When the ADCS-601-AF is connected to the model 3682 ADC, do not execute any function on the 3682 that will cause it to vent pressure unless the ADCS-601-AF is vented first. Causing pressure on the ADCS-601-AF TEST(+) port to vent when the ADCS-601-AF is not vented, may cause damage to the ADCS-601-AF. NOTE: The ADCS-601-AF is always vented before the model 3682 vents if the procedures below are followed as instructed.*

---

The model 3682 validation procedure automatically runs the model 3682 through the required pressure sequence and records actual and test pressure at each point. If the Ps transducer is being run, the **<Offset Check Point>** can be executed before the pressure sequence. When the sequence is complete, the results of the test are stored in a test data file and a report is generated.

To run the validation test proceed as follows:

- ❶ Turn OFF the model 3682, open the console door and set the **RUN/CAL/DIAG** switch to **CAL**.

Connect and IEEE-488 cable (GPIB) from the IEEE-488 connection on the front of the ADCS Control Cabinet to the model 3682 front panel IEEE-488 connection.

Turn the model 3682 back ON and allow one hour warm up to complete.

- ❷ Set the ADCS-601-AF to absolute measurement mode using the **[MODE]** button on the **ADCS Tools Main Run Screen**.

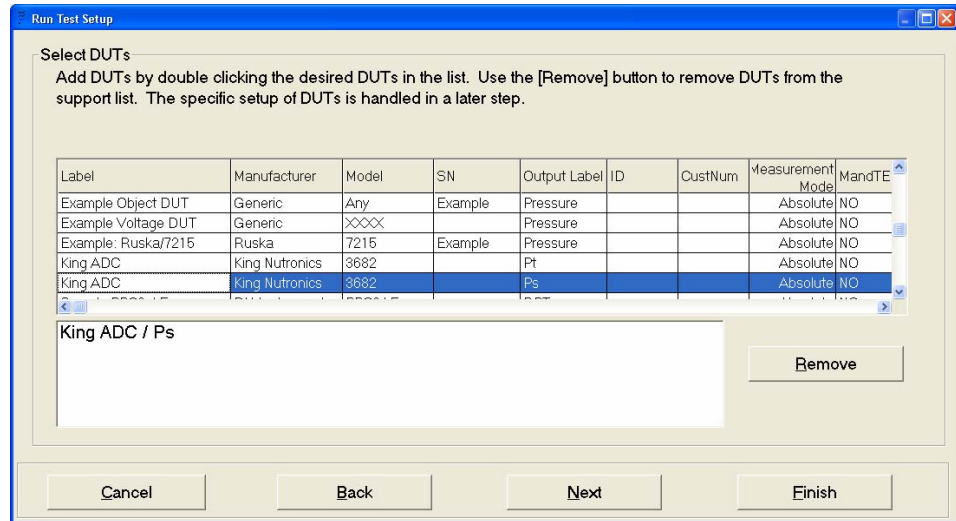
Vent the ADCS-601-AF using the **[VENT]** button on the **ADCS Tools Main Run Screen**.

Enter the appropriate **<Upper Limit>** value on the **ADCS Run Screen**. Enter 32 inHg when calibrating the Ps transducer and 110 inHg when calibrating the Pt transducer.

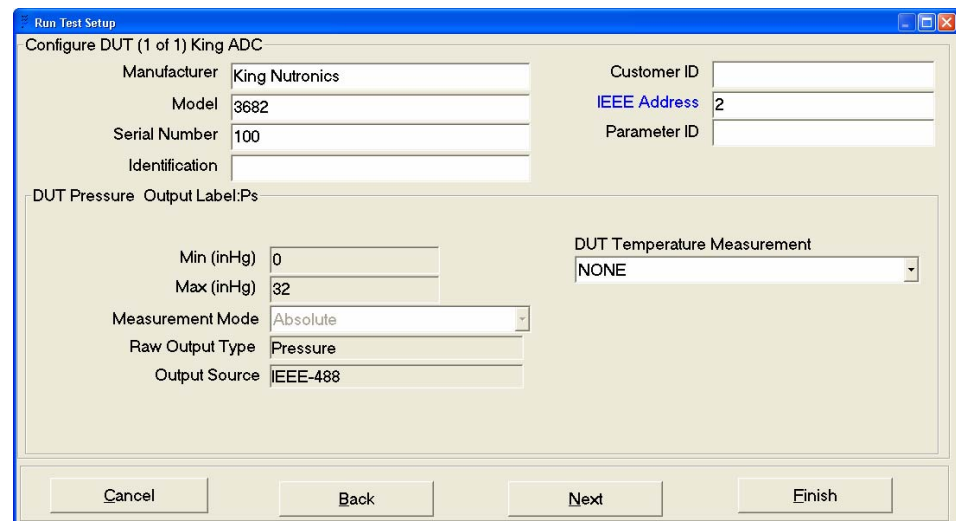
- ❸ Connect the ADCS-601-AF **TEST(+)** port to the 3682 **<Ps>** or **<Pt>** port.
- ❹ Select **[Run][Run Test Definition]** in **ADCS Tools**.
- ❺ Select **<inHg>** as the unit of measure and press **[Next]**. If the same test was previously run with the same instrument and pressure range, press **[Finish]** to automatically use the previous settings.



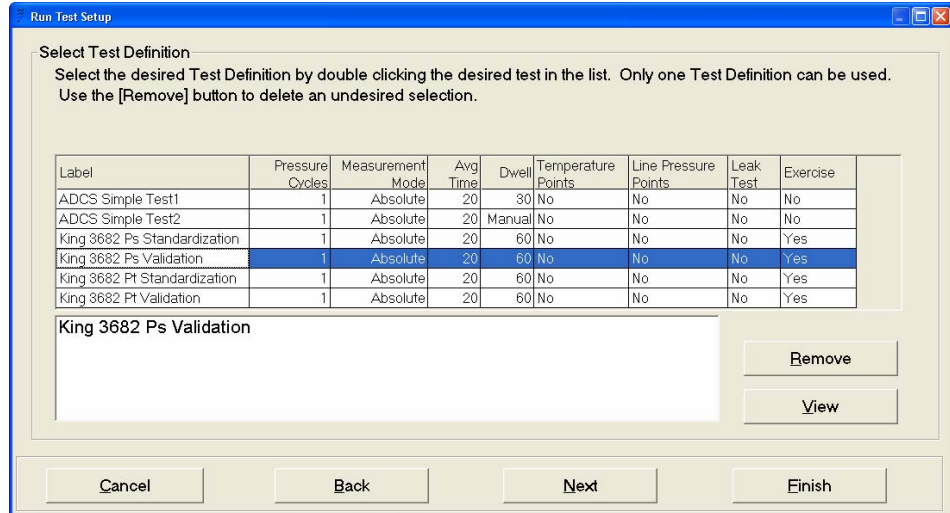
- ⑥ Select the DUT with <Label> <King 3682> and <Output Label> <Ps> or <Pt> as desired. Press [Next].



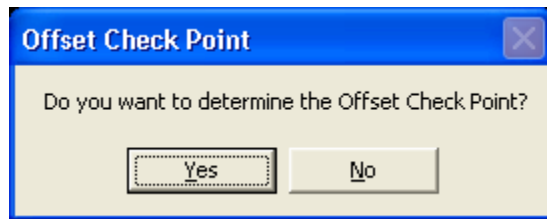
- ⑦ Enter the serial number of the DUT and other identifying information in the fields provided at the top of the display. Do not change to <IEEE Address> Also verify that the range is correct, then press [Next].



- ⑧ Select the <King 3682 Ps Validation> or <King 3682 Pt Validation> test from the list and press [Finish]. There are no further initialization steps. The test will complete initialization and start to run. The status bar updates during initialization to display the current system operation.

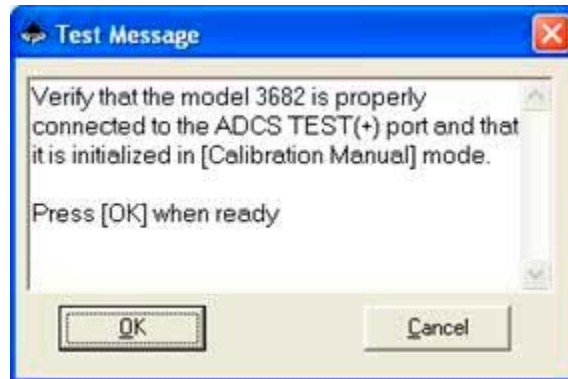


- ⑨ If the DUT and Test selections are for a <Ps> transducer, a prompt asking whether to determine the <Offset Check Point> or not is presented. Press [Yes] on the pop-up window to run this step. It is not necessary to run an offset Check Point when running a test that will determine as received error or when trying to evaluate the DUT. In this case press [No] and skip to Step ⑩.



- ⑩ At the next prompt, do NOT press [OK] before having set the model 3682 to <Calibration Manual> mode. To set <Calibration Manual > mode, on the front panel of the model 3682:
  - Press [Advance]
  - Press [Calibration Manual]
  - Press [Advance]
  - Select [Calibration]
  - Select [PS] or [PT]
  - Press [Advance]
  - Select [Dead Weight Tester]
  - Press [Advance]

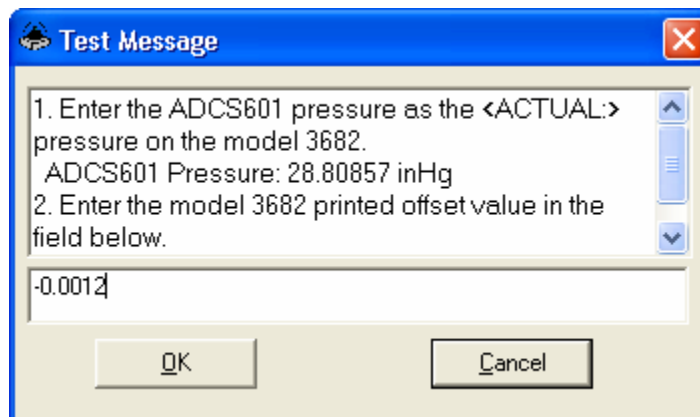
Press **[OK]** only when the model 3682 is in **<Calibration Manual >** mode and the **<PS>** pressure is updating on its front panel display.



- ① **ADCS Tools** provides a prompt of whether to exercise the transducer. Select **[YES]** to exercise the transducer by applying full scale pressure three times with 10 second dwell. Select **[NO]** to skip the exercise step.
- ② The Offset Check Point pressure of 28.8 inHg is set.
- ③ When Ready occurs at the Offset Check Point pressure a popup displays indicating the actual pressure set by ADCS-601-AF.

On the front panel of the model 3682 perform the following operations:

- Press **[MEASURE]**. The **[ACTUAL]** field begins to blink
- Enter the **<ADCS-601-AF Pressure>** displayed on the **ADCS Tools** popup using the numeric keys at the bottom of the model 3682 display. Verify that the information is entered correctly and press **[Enter]**.
- The model 3682 prints the calibration offset value. Enter this value in the edit field at the bottom of **ADCS Tools** popup. The value is stored in the test data file and printed out on reports.
- Press **[OK]** to continue. The ADCS-601-AF vents the pressure immediately after **[OK]** is pressed. It is important that the ADCS-601-AF vent rather than the model 3682 venting the pressure.

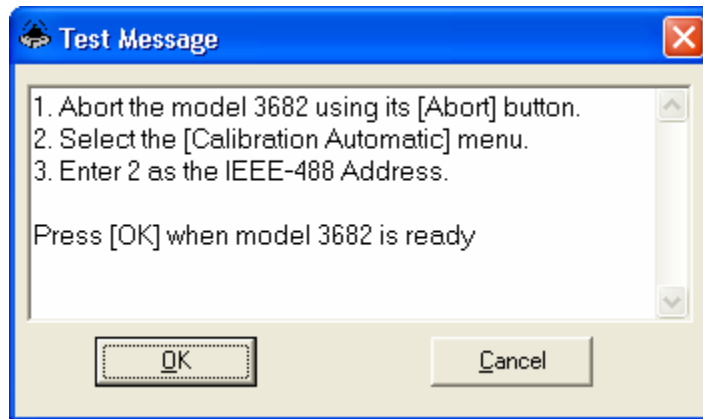


- 14 When prompted by the popup below, abort model 3682 operation by pressing its red **[ABORT]** button. Then set **<Calibration Automatic>** mode and the IEEE-488 address on the model 3682 screen as follows:

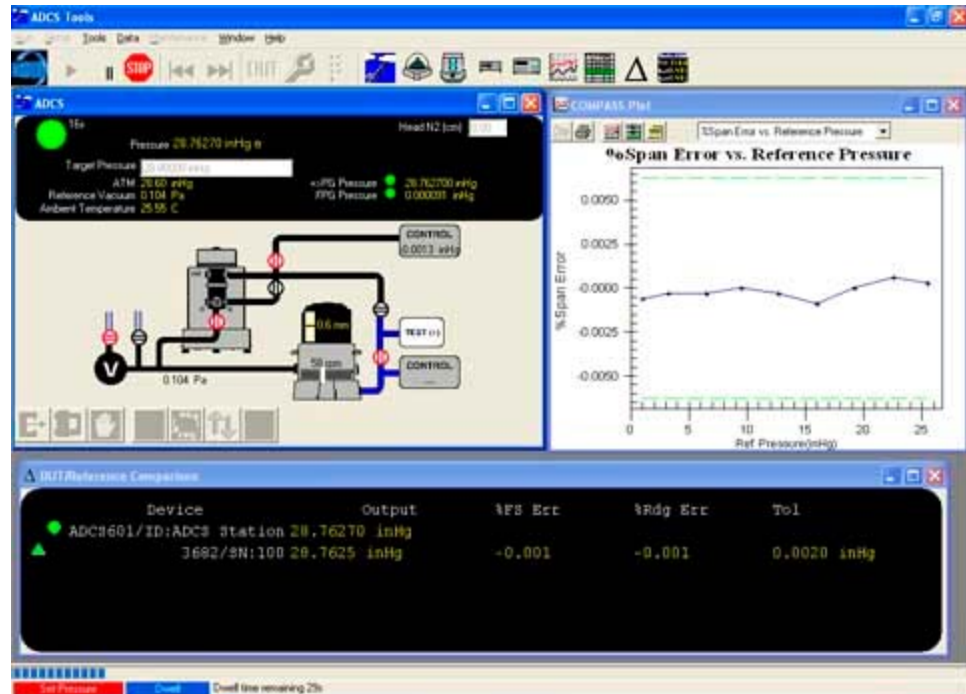
- Press **[Calibration Automatic]**
- Press **[Advance]**
- Press **[IEEE Address]**
- Press **[2]** to set 2 as the IEEE-488 address.
- Press **[Enter]**.

The model 3682 will remain in the IEEE address selection screen until **ADCS Tools** initializes model 3682 communications.

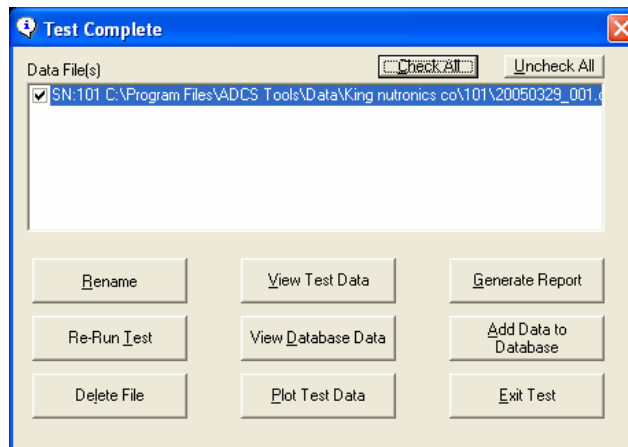
After all steps on the 3682 are complete and its display is the IEEE address selection screen, press **[OK]** on the **ADCS Tools** popup. It is imperative that the model 3682 be in the correct mode of operation when the test begins.



- 15 **ADCS Tools** sets up the the model 3682 remote interface for automatic calibration. Ten to twenty seconds after **[OK]** is pressed, the model 3682 prints out the current mode of operation. **ADCS Tools** proceeds to run the test automatically. The output of the model 3682 and the test progress display on **ADCS Tools** as the test excutes through the test pressure points. Use the display buttons on the **ADCS Tools Main Toolbox** to display other system windows if desired.



- 16 When the test is complete the **Test Complete** form displays. If automatic report generation is enabled (see Section 4.4.2.2), the **Report Editor** creates a report.



#### 4.4.6.2 RUNNING A STANDARDIZATION



When the ADCS-601-AF is connected to the model 3682 ADC, do not execute any function on the 3682 that will cause it to vent pressure unless the ADCS-601-AF is vented first. Causing pressure on the ADCS-601-AF TEST(+) port to vent when the ADCS-601-AF is not vented, may cause damage to the ADCS-601-AF. NOTE: The ADCS-601-AF is always vented before the model 3682 vents if the procedures below are followed as instructed.

The model 3682 standardization procedure steps the operator through the model 3682 required sequence. This procedure cannot be fully automated due to limitations in the model 3682 remote validation procedure.

To run the validation test proceed as follows:

- ① Turn OFF the model 3682, open the console door and set the **RUN/CAL/DIAG** switch to **CAL**. Turn the model 3682 back ON and allow one hour warm up to complete.

Set the model 3682 to **<Calibration Manual >** mode on the front panel:

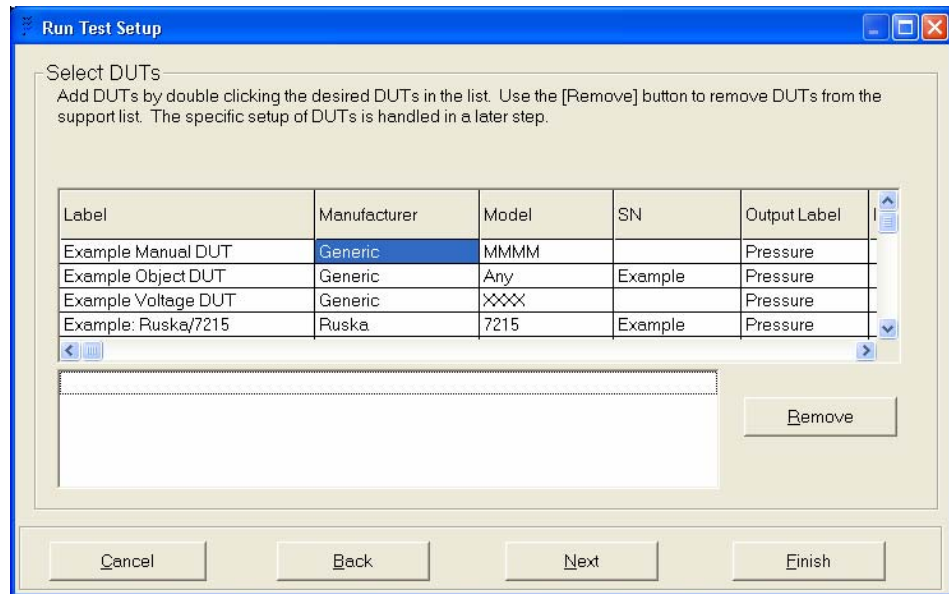
- Press [**A**dvance]
- Press [**C**alibration Manual]
- Press [**A**dvance]
- Select [**S**tandardization]
- Select [**P**S] or [**P**T]
- Press [**A**dvance]
- Press [**A**dvance]

- ② Set the ADCS-601-AF to absolute measurement mode using the [**M**ODE] button on the **ADCS Tools Main Run Screen**.

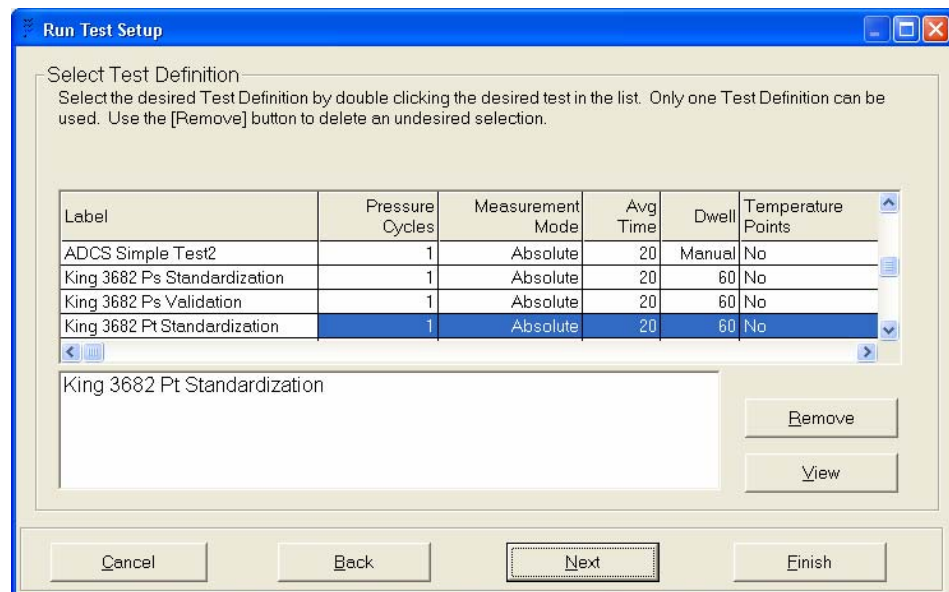
Vent the ADCS-601-AF using the [**V**ENT] button on the **ADCS Tools Main Run Screen**.

Enter the appropriate **<Upper Limit>** value on the **ADCS Run Screen**. Enter 32 inHg when calibrating the Ps transducer and 110 inHg when calibrating the Pt transducer.

- ③ Connect the ADCS-601-AF **TEST(+)** port to the 3682 **Ps** or **Pt** port.
- ④ Select [**R**un][**R**un Test Definition] in **ADCS Tools**.
- ⑤ Select **<inHg>** as the unit of measure and press [**N**ext]. If the same test was previously run with the same instrument and pressure range, press [**F**inish] to automatically use the previous settings.
- ⑥ In the **<Selected DUTs>** panel, do NOT select a DUT. If any DUT is selected, remove it by clicking on it and pressing the [**R**emove] button.  
Press [**N**ext] when ready.



- 7 Select the <King 3682 Ps Standardization> or <King 3682 Pt Standardization> test from the <Select Test Definition> list and press [Finish]. There are no further initialization steps.

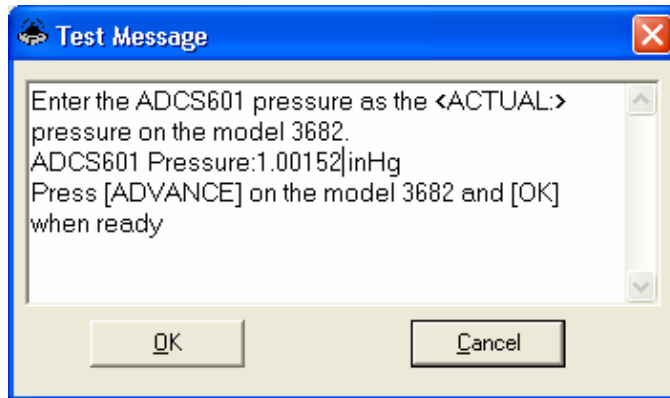


- 8 The test completes initialization and starts to run. The status bar updates during initialization to display the current system operation.

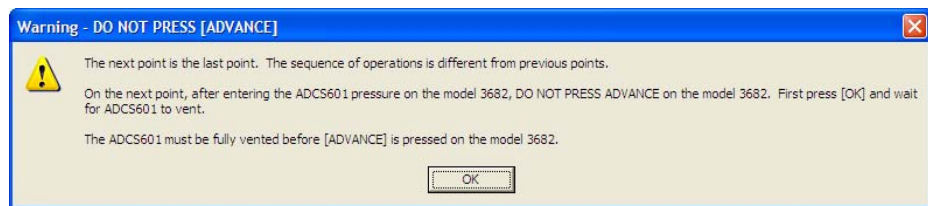



ADCS Tools automatically opens the Data Plot Run Screen (see Section 4.4.3.1) when running a test but there is no relevant data to plot when running a validation test. To close the Data Plot Run Screen, simply click on the [x] in the upper right hand corner of the Run Screen.

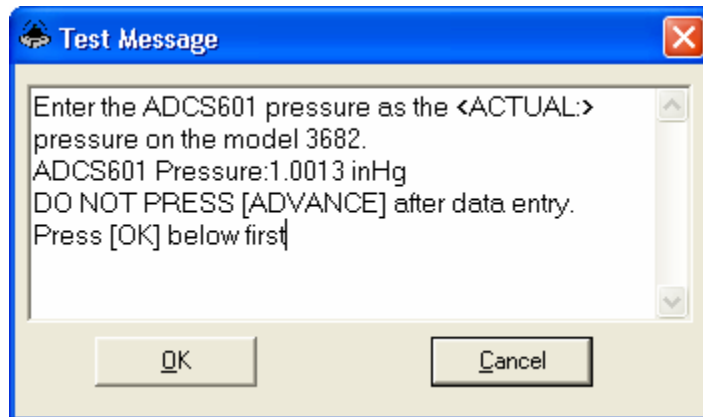
- 9 ADCS Tools sets the test pressure, dwells for 60 seconds, determines the pressure value set by the ADCS-601-AF and prompts the user with a dialog box.



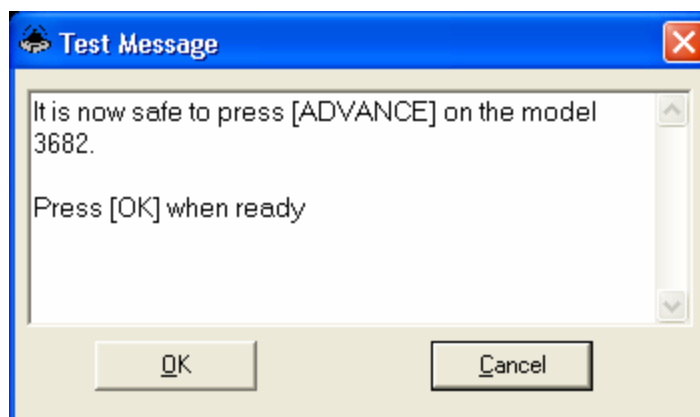
- ⑩ Enter the ADCS-601-AF pressure on the model 3682 front panel as the **<Actual>** pressure. Then press **[ADVANCE]** on the model 3682. Press **[OK]** when ready.
- ⑪ Repeat step ⑩ until the last pressure point of the test. Just before the last point, a special warning dialog box is displayed. The dialog box notifies the operator that the sequence for the last point is different from the other points. **[OK]** must be pressed **BEFORE [ADVANCE]** is pressed on the model 3682.



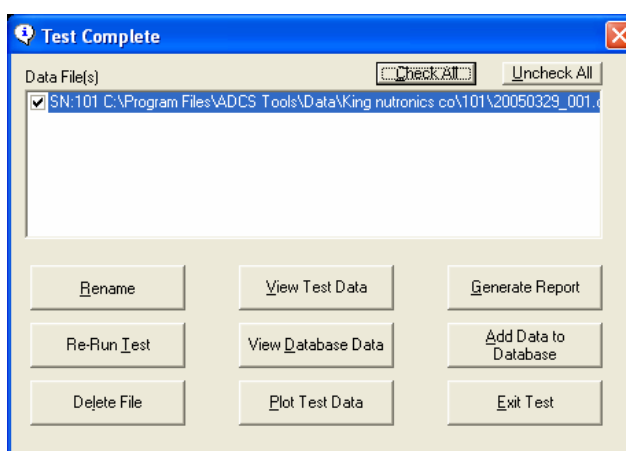
 *On the last test point of the standardization DO NOT press [ADVANCE] on the model 3682 before [OK] has been pressed on the ADCS Tools dialog box and the second dialog box indicating it is safe to proceed appears. Pressing [ADVANCE] on the model 3682 after the last point causes the 3682 to vent while the ADCS-601-AF is still at a set pressure which can damage the ADCS-601-AF.*







- ⑫ When the test is complete the Test Complete form displays. Press **[Exit Test]** to close the dialog box and return to the ADCS Main Run Screen.



- ⑬ On the model 3682, press **[ADVANCE]** and follow its prompts to complete the standardization process.

## NOTES



## 5. REMOTE OPERATION

The overall ADCS-601-AF system is controlled by a Windows based personal computer running **ADCS Tools** software.

Interfacing between a host computer and the ADCS-601-AF system computer is not available at the time of publication of this manual.

Individual ADCS-601-AF components such as the PG7601 and the PPC3 pressure controllers can be addressed individually on their RS232 and/or IEEE-488 interfaces, but this is not a normal part of ADCS-601-AF operation. See the Operation and Maintenance Manual for the individual component for additional information on interfacing with it directly.

## NOTES



## 6. GENERAL MAINTENANCE AND ADJUSTMENTS

### 6.1 SUMMARY

PG7000 was designed for very low maintenance operation. However, certain regular maintenance functions are required to assure reliability and the best performance over time. These are summarized in Table 18, including cross-references to sections of this manual detailing each procedure.

**Table 18.** Mechanical maintenance procedures

SYSTEM	PROCEDURE	DESCRIPTION	FREQUENCY	SEE SECTION
FPG8601	Add water to the bubbling system and purge the trap	Access filter trap and bubbler on rear of FPG8601 Platform to empty trap and add water to bubbler.	Every 3 months or when humidity indicated on <b>FPG8601 Run Screen</b> is out of range low.	6.2
FPG8601	Clean piston-cylinder	Remove piston-cylinder from FPG mounting post, clean and reinstall.	When FPG read out is unstable; when the FPG lubrication gas is known to have been contaminated	6.3
PG7601	Clean piston-cylinder	Remove piston-cylinder module from the PG7601 Platform. Disassemble the module and clean the piston-cylinder. Reassemble and lubricate the module. Install in the PG7601 Platform.	When pressure set by PG7601 is noisy; pressure controller is unable to float piston consistently; rotation time is lower than usual and/or deceleration is faster than usual	6.6
PG7601	Adjust piston position indication system	Run a routine from the PG7000 Terminal with piston in fully down and up positions.	6 months; if pressure control to float PG7601 piston does not operate correctly; if pressure is not stable when piston is floating	6.7
PG7601	Replace piston rotation drive belts	Disassemble PG7601 rotation plate, replace belts and reassemble.	If piston rotation system no longer operates reliably	6.8
PG7601	Adjust on-board vacuum gauge	Run an automated function from <b>ADCS Tools</b> that automatically adjusts the PG7601 internal vacuum gauge to make it agree with the reference vacuum CDG.	6 months	6.9
ADCS Control Cabinet	Change or interrupt <b>TEST GAS SUPPLY</b> ,	If it is necessary to interrupt the pressure supply to the <b>TEST GAS SUPPLY</b> port on the Control Cabinet, a special procedure must be used to be sure supply pressure does not become lower than the pressure in the FPG lubrication circuit.	When it is necessary to interrupt pressure supply to the Control Cabinet <b>TEST GAS SUPPLY</b> port.	6.11
ADCS Control Cabinet	Empty drive air traps	Access drive air traps from front of the control cabinet and drain traps.	3 months, or more frequently if water is observed in traps	6.12
ADCS Control Cabinet	Check/adjust Gas Supply Panel settings	Access Gas Supply Panel from front of the control cabinet and make adjustments to regulators as needed.	3 months or more frequently if gas supplies are unstable	6.13
FPG8601 and PG7601	Adjust PPC3 pressure controllers	Run an automated routine from <b>ADCS Tools</b> that automatically adjusts the PPC3 pressure controllers to agree with their pressure reference (PG7601 or FPG8601).	1 year or if pressure control becomes too slow or unreliable. Use to reduce difference between requested pressure and final pressure when using FPG8601 pressure reference.	6.10



ADCS-601-AF is a sophisticated automated pressure standard with advanced on-board features and functions. Before assuming that unexpected behavior is caused by a system defect or breakdown, use this manual and other training facilities to become thoroughly familiar with ADCS-601-AF operation. For rapid assistance in specific situations, see Section 8, Troubleshooting.



ADCS-601-AF is covered by a limited 1 year warranty (see Section 9.3). Unauthorized service or repair during the warranty period is undertaken at the owner's risk and may cause damage that is NOT covered under product warranty and/or may void the product warranty.

## 6.2 FPG8601, CHECK BUBBLER AND ADD WATER IF NECESSARY



It is critical to never tilt the FPG8601 when there is pressure in the system. If this occurs, water from the bubbler will be forced through the lubrication gas lines and into the lubricating volume. This can cause permanent damage to essential parts of the FPG.

For the FPG8601's load cell to operate properly, it must be surrounded by gas with the appropriate level of humidity (40 to 70% RH). To assure the appropriate level of humidity, the FPG lubrication gas passes through a water filled bubbler and then a pressure reduction before it enters the load cell enclosure.

The bubbler's water supply is consumed over time so the bubbler water level must be checked occasionally and refilled if necessary.

To check the bubbler level proceed as follows:

- ❶ Go to the back of the ADCS-601-AF Reference Bench to observe the back of the FPG8601 Platform (see Figure 45).
- ❷ Observe the water level in the bubbler (clear plastic reservoir on the **right** side looking at the FPG8601 from the rear). The water level should be well over the bottom of the black gas delivery tube so that the gas coming through the tube bubbles through the water.
- ❸ If the water level in the bubbler is low, refill the bubbler (see procedure immediately below).

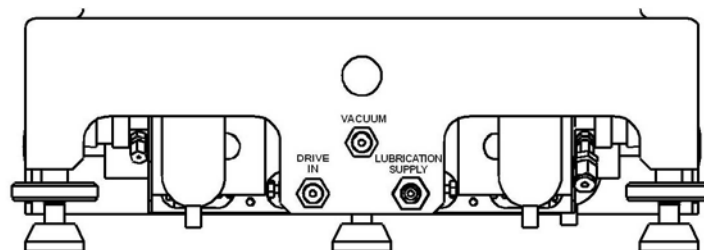


Figure 45. FPG8601 bubbler and filter



In Figure 45, the coalescing filter is on the left and the bubbler is on the right. This view is looking at the back of the FPG8601.

To refill the FPG8601 bubbler proceed as follows:

- ❶ Prepare the ADCS-601-AF system for access to the bubbler:  
  
Set gauge measurement mode using the **[MODE]** button on the **ADCS Run Screen Toolbar** (see Section 4.3.5.3). Wait for the process to complete.  
  
Shut down the FPG8601 system by pressing the **[OFF]** button on the **ADCS Tools FPG Run Screen** (see Section 4.3.6.2). Wait until the shut down procedure is complete (FPG Pressure is < --- **SHUTDOWN** --- > and indicates *Ready*, see Section 4.1.1).
- ❷ Drain the coalescing filter by placing an absorbent wipe under the filter, then pressing the button on the bottom of the filter.
- ❸ Remove the bubbler by turning the plastic volume counter-clockwise.
- ❹ Fill the bubbler to about 30 % of its capacity with **clean distilled water**.
- ❺ Reinstall the bubbler. Tighten the plastic volume 1/4 turn clockwise until it feels snug against the O-ring.
- ❻ Verify that the FPG is level using the bubble level on the top of the platform.
- ❼ Restart the FPG8601 by pressing the **[ON]** button on the **FPG Run Screen** (see Section 4.3.6.2). Wait until the FPG8601 start up procedure is complete.
- ❽ ADCS-601-AF should now be ready to resume normal operation.

## 6.3 FPG8601, REMOVE CLEAN AND REINSTALL THE PISTON-CYLINDER

### 6.3.1 OVERVIEW



*Read this section completely before electing to remove, clean and reinstall the FPG8601 piston-cylinder assembly. Consider restoring piston-cylinder mobility procedures (see Section 6.3.7) before undertaking piston-cylinder cleaning. In normal operation, the FPG8601 piston-cylinder should operate reliably for many months or indefinitely without the piston-cylinder needing to be cleaned.*

---

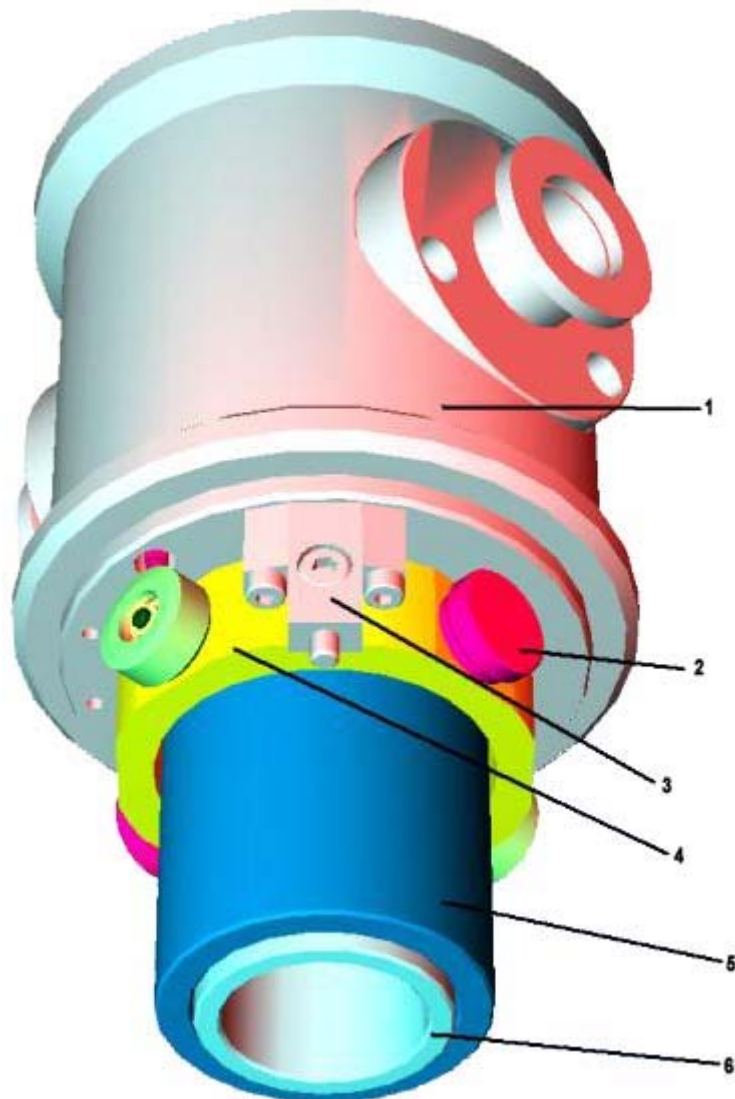
The FPG8601 piston-cylinder may have to be removed, cleaned, and reinstalled into the FPG8601. In normal operation, the FPG8601 piston-cylinder will operate for many months or indefinitely without needing to be cleaned. There is no scheduled piston-cylinder cleaning interval, cleaning should only be undertaken when necessary.

Maintenance cleaning may be necessary if the FPG8601 has been back pressured or if the piston is not supplied with lubricating gas pressure for extended periods. Back pressuring occurs when the pressure in the piston-cylinder mounting post exceeds the pressure in the lubricating volume. The most common symptom of a dirty piston is noisy readings when the system is properly lubricated with gas pressure and at zero pressure. See Section 6.3 for procedures to remove, clean and reinstall the piston-cylinder.

The FPG8601 readings may also become noisy if the piston is no longer well centered in the cylinder. This may occur when installing the piston-cylinder or due to back pressure or lack of lubricating pressure. When this occurs, the piston-cylinder needs to be manipulated to reestablish the gas film between the piston-cylinder that lubricates them so the piston is perfectly mobile. When FPG8601 pressure readings are noisy, unless very obvious signs of contamination are present, always try piston-cylinder manipulation to establish normal behavior before disassembling and cleaning the piston-cylinder. See Section 6.3.7 for the procedure to reestablish piston mobility.



*Failure to follow each of the FPG8601 piston-cylinder disassembly/assembly steps can cause permanent damage to essential parts of the FPG8601.*



- |  |                |
|--|----------------|
| 1. Upper mounting post                   | 4. Gimbal ring |
| 2. Piston retaining nut                  | 5. Cylinder    |
| 3. Indexing block with 3 mm indexing pin | 6. Piston      |

**Figure 46.** FPG8601 piston-cylinder assembly in mounting post



### 6.3.2 REMOVING THE PISTON-CYLINDER FROM THE MOUNTING POST



Unless the piston-cylinder is obviously contaminated, consider using in situ methods to restore mobility of the piston in the cylinder before removing it and cleaning it (see Section 6.3.7).

The following procedure describes the steps to be taken in order to safely remove the piston-cylinder from the mounting post. Great care must be taken when removing the assembly. Permanent damage can occur if the recommended steps are not specifically followed.

- ❶ Prepare the ADCS-601-AF system for access to the piston-cylinder:

Set gauge measurement mode by pressing the **[MEASUREMENT MODE]** button on the **ADCS Run Screen Toolbar** and selecting **<gauge>** (see Section 4.2.3). Wait for the measurement mode change process to complete.

Shut down the FPG8601 system by pressing the **[OFF]** button on the **FPG Run Screen** (see Section 4.3.6.2). Wait until the shut down procedure is complete (FPG8601 Pressure is **< --- SHUTDOWN --- >** and indicates *Ready*).



The PG7601 and FPG8601 reference vacuum CDGs are delivered with an isolation valve connected to them. This valve is normally closed and serves to maintain vacuum on the CDG at all times as exposing the CDG to atmospheric pressure will cause zero shifts. Do not break the valve fittings or operate the valve without establishing vacuum first.

- ❷ Remove the vacuum isolation valve (valve 9) on the bottom of the lower mounting post and remove the vacuum reference CDG and valve (see Sections 3.3.10.2, 7.2.6).
- ❸ Detach the bottom mounting post PRT by unscrewing the knurled nut on the back of the mounting post.
- ❹ Apply a slight upward pressure with one hand under the lower mounting post (see Figure 47).
- ❺ Loosen the nut at the center of mounting post.



The upper and lower mounting post are held together by a large surface area retaining nut that compresses an O-ring between the mounting post halves. Pressing upward on the lower mounting post allows the mounting post nut to be easily unscrewed with one hand. If pressure is not applied to the lower mounting post, the mounting post nut can remove small particles from the mounting post and possibly cause contamination.

- ❻ With the other hand, completely unscrew the mounting post nut.
- ❼ Lower the mounting post down as straight as possible.



If the lower mounting post is not lowered in vertical descent, it will make contact with the external surface of the cylinder. If this happens, contaminants can be introduced into the low-pressure chamber of the mounting post.

- ❽ Fully remove the lower mounting post and set it on a clean surface.



Figure 47. Removing the FPG8601 mounting post

- ⑨ Put on gloves.



*NEVER touch the lapped surfaces (polished appearance) of the piston or cylinder with your bare hands. Body oils and acids can permanently etch the surfaces.*

---

- ⑩ Remove one of the piston retaining nuts.



Figure 48. Removing the FPG8601 piston-cylinder

- ⑪ With one hand supporting the piston to maintain its current position, slowly remove the remaining piston retaining nut.

- ⑫ Cup the piston-cylinder in your hand, remove the indexing pin (see Figure 48) and allow the piston-cylinder to drop in a straight vertical descent.
- ⑬ Place the piston-cylinder on a flat surface on several lint-free towels.



When placing the piston-cylinder on the table, make sure to set it down in the vertical position. If the piston-cylinder is set down in a horizontal position, there is a risk of the assembly rolling off the table causing permanent damage.

### 6.3.3 REMOVING THE PISTON FROM THE CYLINDER



Never attempt to remove the piston from the cylinder without using the special piston insertion tool and the procedure described in this section. Doing otherwise can result in the piston cocking as it leaves the cylinder and damage to both parts.

As the piston and cylinder are very high precision parts with a gap as small as one micron, a special tool and procedure is required to remove one from the other without risk of the piston cocking in the cylinder and binding as it leaves the cylinder.

When removing the FPG8601 piston from its cylinder, proceed as follows:

- ① Remove the cup from the spindle of the FPG8601 insertion tool and place both on a flat, stable surface.
- ② Lift the piston-cylinder by the outside of the cylinder and the inside of the piston. Place the piston-cylinder into the insertion tool.



NEVER touch the lapped surfaces (polished appearance) of the piston or cylinder with your bare hands. Body oils and acids can permanently etch the surfaces.

- ③ Lift the cup and slowly slide it down onto the spindle. The piston is stopped by the ledge at the top of the spindle while the cylinder continues to move down with the cup.
- ④ Using gloves and minimizing contact with the outside polished surface of the piston, remove the piston from the FPG8601 piston insertion tool.
- ⑤ Slide the cup containing the cylinder up and off the spindle. Remove the cylinder from the cup.



### 6.3.4 CLEANING THE PISTON AND CYLINDER

When a piston-cylinder has been shipped, it should usually be cleaned before it is installed in the FPG8601. Cleaning the piston-cylinder may also be necessary to correct noise in FPG8601 pressure measurements caused by poor mobility of the piston due to contamination between the piston and the cylinder.

To clean the piston-cylinder, it must first be removed from the FPG8601 and the piston taken out of the cylinder (see Sections 6.3.2, 6.3.3). Once the piston and cylinder is removed and separated, proceed as follows:

- ❶ Place two clean lint-free towels on a flat surface.
- ❷ Place the piston in the horizontal position on the two lint-free towels.
- ❸ Using gloves, fold two other lint-free towels three times over, and mist slightly with Windex® glass cleaner.
- ❹ Gently wipe the piston with the misted, lint-free towels while rolling the piston on the two flat lint-free towels.
- ❺ Make sure to cover all 360 degrees of the piston over its full length.
- ❻ Lay two more clean, lint-free towels on a flat surface.
- ❼ Discard misted lint-free towels.
- ❽ Transfer the piston to the two clean, lint-free towels.
- ❾ Using gloves, fold two new lint-free towels three times over.
- ❿ Buff the piston while rolling it on the flat surface.
- ⓫ Repeat Step ❿ twice.



*This step is critical, if any glass cleaner is left on the piston, the piston will not be mobile when it is reassembled and the FPG8601 pressure output will be noisy.*

---

- ⓬ Blow off the piston with very clean forced air.
- ⓭ Fold another lint-free towel three times over, and mist slightly with glass cleaner.
- ⓮ Roll lint-free towel (glass cleaner side out) around two fingers.
- ⓯ Place glass cleaner side of the lint-free towel against the inside surface of the cylinder.
- ⓰ Rotate the cylinder around while wiping the inside surface with an in and out motion.
- ⓱ Repeat on both ends of the cylinder.
- ⓲ Fold another two lint-free towels three times over.
- ⓳ Again, wrap the lint-free towels around two fingers.
- ⓴ Rotate the cylinder around while wiping the surface with an in and out motion.
- ⓵ Repeat Step ⓲ and ⓴ two more times.
- ⓶ Repeat Step ⓲ and ⓴ for both ends of the cylinder.
- ⓷ The cleaning process is complete and the piston can now be put back into the cylinder. The instructions in Section 6.3.5 must be followed to safely put the piston in the cylinder.

### 6.3.5 PUTTING THE PISTON INTO THE CYLINDER



Never attempt to put the piston into the cylinder without using the special piston insertion tool and the procedure described in this section. Doing otherwise can result in the piston cocking in the cylinder and damage to both parts.

When the piston has been removed from the cylinder, it must be put back into the cylinder before the piston-cylinder can be reinstalled in the FPG8601 Platform.



**Figure 49.** Alignment of the FPG8601 piston in the cylinder



The piston must be installed in the cylinder with the correct end at the top and the correct rotational orientation. Installing the piston incorrectly in the cylinder may result in poor FPG8601 performance and/or out of tolerance measurements.

- ❶ Place the cylinder in the FPG8601 piston insertion tool cup so that the serial number etched on the outside of the cylinder is towards the top and right side up.
- ❷ Slide the cup and cylinder all the way down the insertion tool spindle.



- ③ Using gloves and minimizing contact with the outside polished surface of the piston, carefully place the piston on the top of the piston insertion tool. The serial number etched on the inside of the piston should be towards the top and right side up. The serial number of the piston should be adjacent to the serial number on the cylinder (see Figure 49).



- ④ Slowly lift the cup and cylinder up until the piston enters the cylinder and the cup begins to lift the piston. Lift the cup, piston, and cylinder off of the spindle.



- ⑤ The piston-cylinder is ready to be installed in the FPG8601 platform.

### 6.3.6 INSTALLING THE PISTON-CYLINDER IN THE MOUNTING POST

- ① Once the piston has been put into the cylinder (see Section 6.3.5), place the silicon O-ring carrier assembly on the upper portion of the cylinder (lip up). The silicon O-ring is orange and more soft than the Viton O-ring, do not confuse the two.
- ② Place the Viton O-ring carrier inside the lower mounting post (lip down). The Viton O-ring is a brownish color and is firm relative to the silicon O-ring.
- ③ Carefully slide the piston-cylinder assembly into the upper mounting post. Make sure that the serial numbers on the piston-cylinder are aligned, and that the marked surfaces are oriented upwards (see Figure 49).
- ④ Align the indexing hole of the cylinder with the hole on the indexing block.
- ⑤ Insert the cylinder retaining screw into the indexing block and the cylinder.
- ⑥ Position the holes on the piston so that they align with the gimbal ring and cylinder holes (where the piston retaining pins will go).
- ⑦ Insert one piston retaining pin and thread it half way in.
- ⑧ Insert the remaining piston retaining pin so that it is tight.

- 9 Tighten the first piston retaining pin.
- 10 Verify that both retaining pins are tight.
- 11 Verify that the silicon O-ring is in place on the upper mounting post (between the upper and lower mounting post).
- 12 Attach the lower mounting post, aligning it with the cylinder.
- 13 Place a hand under the lower mounting post and firmly press up.
- 14 With the other hand, thread the mounting post nut mating the upper mounting post to the lower mounting post.
- 15 Restart the FPG by pressing the **[ON]** button on the **FPG Run Screen** (see Section 4.3.6.2). Wait until the start up procedure is complete. NOTE: If this is the initial FPG8601 start up, the **FPG Tools** software is not running yet. Open the door on the front of the Control Cabinet and set the **FPG DRIVE** regulator as specified in Section 6.13. Then return to Section 3.3.10.2.
- 16 Wait at least five minutes with the FPG at zero pressure. If the pressure (FPG8601 load cell output **<N>**) is noisy, the piston and cylinder may require **lubrication** restoration procedure (see Section 6.3.7) or re-cleaning (see Section 6.3.4).

### 6.3.7 RESTORING PISTON-CYLINDER LUBRICATION AND MOBILITY

#### 6.3.7.1 OVERVIEW

For the FPG8601 piston-cylinder to operate properly, the piston must be well centered in the cylinder so that it is free and mobile. The piston is lubricated and centered by the flow of lubricating gas from the center of the piston-cylinder through its upper and lower conical gaps (see Section 2.2.2). While the lubricating gas flow can maintain the piston centered in the cylinder, for its action to be effective, the piston must first be well lubricated with gas and centered in the cylinder.

A piston-cylinder that has just been installed in the FPG8601 mounting post may not be well enough centered and lubricated for the lubricating gas flow to center it. The piston centering may also be lost if the lubricating gas flow is interrupted. The symptom of this condition is noisy output of the pressure even when the pressure is stable, in particular when the FPG8601 is being zeroed or when the lower mounting post has been removed.

When the FPG8601 output is noisy it often is not because the piston-cylinder is dirty. It is because it is not well centered and lubricated.

The four procedures described in Section 6.3.7.2 should be used to center the piston in the cylinder and lubricate it before applying the lubricating pressure.

If the centering methods do not reestablish stability, the piston-cylinder may need to be cleaned (see Section 6.3.4).

It is not unusual to need to repeat the procedures multiple times.

#### 6.3.7.2 PISTON CENTERING AND LUBRICATING METHODS

The four procedures below are used to prepare the piston-cylinder for application of the lubrication pressure.

These procedures are used with the piston-cylinder installed in the mounting post but with the lower mounting post removed so that the piston-cylinder can be



accessed and manipulated. Remove the lower mounting post following the instruction in Section 6.3.2, but do not remove the piston-cylinder.

Observe the value of <N> on the **ADCS Tools FPG Run Screen** (see Section 4.3.6.2). This is the output of the FPG8601 load cell. Alternate the four methods until the output of the load cell is consistently stable  $\pm 1$  or 2 counts. Then install the lower mounting post and start the FPG8601 by pressing the **[On]** button on the **ADCS Tools FPG Run Screen**. The FPG8601 output (display of <N>) should increase and then stabilize again  $\pm 1$  or 2 counts. If it does not, remove the lower mounting post and repeat the process.

**METHOD 1:**  
**CYLINDER MANIPULATION**

Hold the cylinder. Gently move it up and down while rotating it. The movement is very limited. Do not force it.



**METHOD 2:**  
**LIFT AND DROP**

Put a finger under each of the piston retaining nuts. Gently lift the piston compressing the load limiting springs on the piston connecting rods. The movement is very limited. Do not force the piston up. Once the piston is up, let it drop down abruptly.



**METHOD 3:**  
**PULL DOWN AND RELEASE**

Hold the piston retaining nuts. Gently pull the piston down compressing the load limiting springs on the piston connecting rods. The movement is very limited. Do not force the piston down. Once the piston is down, release it suddenly.



**METHOD 4:**  
**STRUM**

Place an index finger on the circular bearing on the side of the gimbal ring. Lightly “strum” the bearing to cause a small amount of movement and let the ring return naturally. The movement is very limited. Do not force it.





## 6.4 PG7601, DISASSEMBLE PLATFORM AND REMOVE MOUNTING POST PRT



*It is not normally necessary to remove the mounting post PRT for recalibration. It can be recalibrated in-situ by comparison with a reference PRT (see Section 7.3.4.).*

To disassemble the platform and remove the mounting post platinum resistance thermometer, proceed as follows:

- ❶ Remove the piston-cylinder module from the mounting post (see Section 6.6.1) and replace with the ORANGE storage plug.
- ❷ Disconnect the PG7000 Platform from the PG7000 Terminal.
- ❸ Invert the PG7000 Platform so that the bottom of the platform is up. Support the platform so that it does not tip over. A simple solution is to place the platform upside down on a sturdy box which is smaller than the outside platform dimensions and is also tall enough to allow the mounting post to be suspended.
- ❹ Remove the six socket head screws (3 mm) around the perimeter of the platform.
- ❺ Lift the base cover plate gently and carefully disconnect the sensor leads at their board connections, noting their locations. Remove the cover plate and electronic board attached to it.
- ❻ Loosen - **but do not remove** - the four socket head screws (3 mm) located on the PRT/cable pass through plate. The plate is located on the inside of the base.
- ❼ Slide the PRT out of the mounting post.

To reassemble continue as follows:

- ❸ After reinserting the PRT into the mounting post and tightening the four socket head screws, reassemble following the steps above in reverse order. Thermal grease may be applied lightly to the PRT, if available. If the sensor lead locations were not noted correctly, follow Table 19.
- ❹ Power up PG7000 and verify proper operation of all on-board sensors.

**Table 19.** PG7601 mounting post wire colors, description and location

WIRE COLORS	DESCRIPTION AND LOCATION
Black/Yellow/White	RPM (P4)
Black/Black/Black/Black	Vacuum Sensor (center raised micro board)
White/White/Yellow/Yellow	Mounting Post PRT (P2)
Purple/Blue/Red	Motor Solenoid (J2)
Gray/Orange/Green/Brown	LVDT (P1)

## 6.5 PG7601, REMOVE AND REINSTALL THE AUTOMATED MASS HANDLER AND MASS SET

To access the PG7601 piston-cylinder or platform, it is necessary to remove the automated mass handler (AMH) and mass set (see Section 6.5).

### 6.5.1 THE MASS HANDLER (AMH)

---



*When installing the mass set and AMH, start by loading the masses (see Section 6.5.2).*

---

To install the AMH-38 mass handler, see below in this section.

#### **REMOVING THE AMH-38 AUTOMATED MASS HANDLER**

To remove the AMH-38 mass handler from the PG7601 Platform, proceed as follows (see Figure 50).

❶ **Prepare the ADCS-601-AF system for local operation of PG7601 and access to the mass set:**

Put the ADCS-601-AF system into gauge measurement mode (see Section 4.2.3).

Vent the ADCS-601-AF system by pressing the **[VENT]** button on the **ADCS Run Screen Toolbar**. Wait for the operation to complete.

Press the **[Pause]** button on the **ADCS Main Tool Bar** to suspend remote communication within the ADCS-601-AF system.

Press **[ESC]** on the PG7000 Terminal to gain local access.

- ❷ **Load all the mass:** Use **[SPECIAL]**, **<8AMH>**, **<2control>**, **<3loadall>** on the PG7000 Terminal to load all the masses of the AMH mass set. This assures that no masses are retained in the AMH so it will be able to be lifted off the platform freely.
- ❸ **Remove the PG7601 bell jar and disconnect the vacuum connection from the AMH vacuum chamber:** Remove the Pyrex® bell jar and set aside. Remove the flange from the KF-40 connection on the right side of the AMH vacuum chamber and break the connection so that the AMH vacuum chamber will be able to lift off the PG7601 Platform. The PG7601's external CDG may be removed from the vacuum chamber as well if desired (see Section 7.2.6).
- ❹ **Remove the AMH mass lifting shaft:** Use the 3 mm allen wrench supplied in the AMH-38 accessories to loosen and unscrew the shaft. **NOTE THAT SHAFT HAS A LEFT HAND THREAD SO IT MUST BE ROTATED CLOCKWISE TO LOOSEN IT.** Slip the shaft up and out of the mass handler.
- ❺ **Lift the AMH-38 off of the PG7601 Platform:** Using the handles on the side of the AMH-38 vacuum chamber, lift the AMH-38 straight up until it clears the masses and set it on a flat surface. The AMH-38 mass handler weighs about 18 kg (40 lb.). The AMH-38 may be placed on top of the Control Cabinet.
- ❻ **To access the PG7601 piston-cylinder and/or platform, remove the mass set (see Section 6.5.2).**

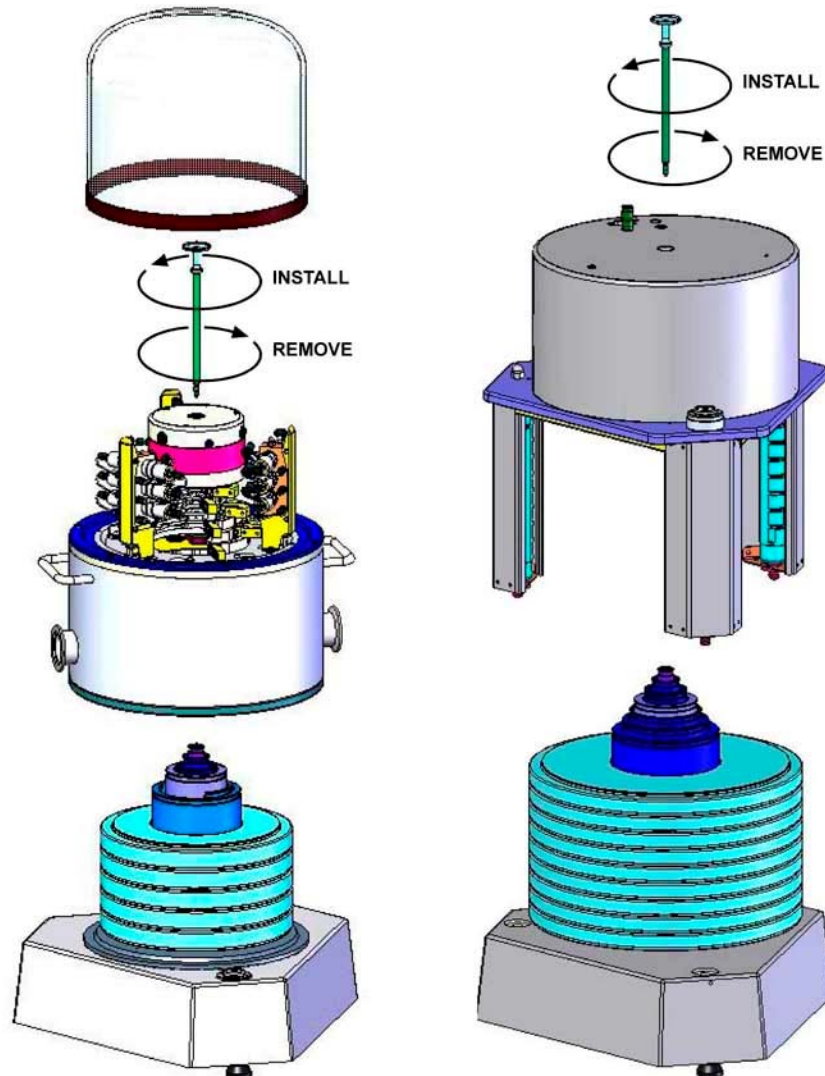


Figure 50. AMH installation on PG7000 Platform

### **INSTALLING THE AMH-38 AUTOMATED MASS HANDLER**

To install the AMH-38 mass handler on the PG7601 Platform, first install the mass set (see Section 6.5.2). Then proceed as follows (see Figure 50).

- ❶ **Insert the mass lifting shaft into the AMH:** With the AMH-38 sitting on a flat surface and with all pneumatic and electrical connections in place, insert the mass lifting shaft into the hole in the center of the AMH mass lifter and slide it down until the trim mass tray sits on the top of the lifter. This arrangement trips the AMH's internal proximity sensor allowing the AMH system to be operated off of the PG7000 Platform without an actual mass load.
- ❷ **Clear the AMH and test its operation:** On the PG7000 Terminal, press [**SPECIAL**], **<8AMH>**, **<2control>**, **<3loadall>**. The trim mass tray should rise approximately 2.5 cm (1 in.) above the top of the lifter. Then the trim mass tray should be lowered back down. The steps of this procedure are commented on the PG Terminal display as they occur. If the sequence does not complete and/or any error messages are observed, see the AMH Operation and Maintenance Manual for troubleshooting assistance. If the sequence completes, the mass handler has been cleared and put into a known state in which all mass holding ledges and pins are retracted so that it can safely be slipped down over the mass set and installed on the PG7000 Platform (see Figure 50).

When this step is complete, the AMH mass handler is ready to be installed on the PG7000 Platform.



To avoid possible damage to the AMH automated mass handler, always perform the initial start/verification procedure described in ❶ and ❷ BEFORE attempting to install AMH on the PG7000 Platform. Failing to do so, may result in attempting to install AMH with mass selection columns or pins in the incorrect position, which can damage the AMH mass handler and/or masses.

---



Do not operate the AMH with drive pressure lower than 275 kPa (40 psi). Damage to the AMH could result.

---

- ❸ **Lift the AMH-38 onto the PG7601 Platform:** Check that the O-ring on the bottom surface of the AMH-38 vacuum chamber is well seated. Using the handles on the side of the AMH-38 vacuum chamber, lift the AMH-38 above the PG7601 Platform and masses. Center it over the mass load and gently lower it down until the bottom circumference of the AMH-38 vacuum chamber contacts the PG7601 vacuum plate. Check that the vacuum chamber is well aligned on the vacuum plate.

Rotate the chamber to align its KF40 connection with the mating connection on the bench. Make the KF40 connection by installing the KF40 centering ring assembly and flange.

- ❹ **Install the mass lifting shaft:** Slip the threaded end of the shaft down through the hole in the center of the mass lifter. Thread the shaft into the binary mass carrier by holding and rotating the trim mass tray. NOTE THAT SHAFT HAS A LEFT HAND THREAD SO IT MUST BE ROTATED COUNTER-CLOCKWISE TO TIGHTEN IT. Use the 3 mm allen wrench supplied in the AMH-38 accessories to tighten the assembly until you feel the mass start to rotate.
- 



It is imperative that the mass loading shaft be fully threaded into the binary mass tray. Be sure to use the T handled 3 mm allen wrench to tighten the shaft to the end of the threads applying sufficient torque to cause the mass load to rotate. Failure to fully screw in the shaft will cause misalignment between the mass handler and the mass load that may cause damage to the AMH-38 mass handler when operated.

---

**Install the bell jar:** Install the PG7601 Pyrex® bell jar over the upper portion of the AMH mass handler.

**Reinstall the reference vacuum DCG assembly:** If the CDG assembly has been removed, reinstall it at the KF40 connection on the AMH vacuum chamber.

- ❺ **Resume normal ADCS-601-AF operation:** Press [ESC] on the PG7601 until its main run screen appears.

Press [PAUSE] on the **ADCS Main Tool Bar** (see Section 4.3.3) to resume normal ADCS-601-AF system operation.

---



Do not operate AMH-38 when using a PG7601 in “absolute by vacuum” mode without having a vacuum supply connected to AMH-38. Always check that AMH-38 is supplied with vacuum before establishing reference vacuum in the AMH-38 vacuum chamber. NEVER plug the AMH drive vacuum port. Failure to do so may result in damage to the binary mass pins and/or binary masses.

---

## 6.5.2 THE MASS SET



When removing the AMH and mass set, start by removing the AMH mass handler. See Section 6.5.1.

PG7000 AMH masses are shipped in reusable, molded shipping and storage cases. One of the cases contains the binary masses, binary mass carrier, mass bell and lifting shaft/trim mass tray. The other cases contain the main masses of 6.4 kg (see Table 7 for mass set parts list). Each mass is packed in a sealed plastic bag and then placed in a protective shipping insert.



The stability over time of the PG7601 pressure measurements is a function of the stability of the masses loaded on the piston. Precautions should be taken in handling the masses to minimize influences that may change their mass. This includes always wearing protective gloves when handling the masses to avoid contaminating them with body oils and perspiration. Protective gloves are provided in the PG7601 accessory kit.

To install the AMH mass set, follow the order of operation below carefully (refer to Figure 51):

- ❶ **Prepare the masses:** Open the shipping cases and remove all the masses and mass set elements from their plastic bags.
- ❷ **Install the piston-cylinder module in the PG7601 Platform:** See Section 6.6.2.
- ❸ **Install the binary mass carrier:** Place the pyramidal shaped carrier on top of the piston cap.
- ❹ **Install the mass loading bell:** Slip the mass loading bell over the binary mass carrier and slide it down until the inside top of the bell sits on the binary mass carrier.
- ❺ **Install the main mass discs:** Load the main mass discs (6.4 kg each) onto the mass bell **starting with mass #1 and loading in sequential order**. Mass #1 should be at the bottom of the stack and the highest number mass at the top. The mass sequence numbers are laser marked on the top surface of each mass. Pass the mass disc over and down the mass loading bell and center it on the ledge at the bottom of the bell. Load the rest of the main masses, sequentially, onto the bottom mass.
- ❻ **Install the binary mass tubes:** Load the binary mass tubes concentrically from the largest to smallest, outside to inside. The largest, long tubes slip down between the main mass stack and the bell and rest on the ledge at the bottom of the mass bell. The smaller masses load onto the pyramidal steps of the binary mass carrier.
- ❼ **The mass loading process is complete:** The mass set is in the all loaded position. The mass lifting shaft/trim mass tray assembly is not yet installed. It will be attached after the AMH automated mass handler is installed over the masses on the platform.



SHOWN IS THE MS-AMH-38 MASS SET FOR THE AMH-38 MASS HANDLER. SMALLER MASS SETS MAY INCLUDE LESS MAIN MASS DISCS. MASS SETS FOR THE AMH-100 MASS SET ARE IDENTICAL TO AMH-38 BUT THE MAIN MASSES ARE LARGER 10 KG DISCS AND A 7TH BINARY MASS TUBE OF 6.4 KG IS INCLUDED.

Figure 51. AMH mass set

## 6.6 PG7601, REMOVE, CLEAN AND REINSTALL THE PISTON-CYLINDER MODULE

It may be necessary to remove the piston-cylinder module from the PG7601 Platform to clean the piston-cylinder or have it recalibrated. For instructions on removing the piston-cylinder module, disassembling, cleaning and reinstalling it, see Sections 6.6.1 to 6.6.3.4.

### 6.6.1 REMOVING THE PISTON-CYLINDER MODULE

To remove the piston-cylinder module, remove the AMH automated mass handler and mass set from the PG7601 Platform (see Section 6.5).

Once the AMH automated mass handler and mass set have been removed from the PG7601 Platform, proceed as follows to remove the piston-cylinder module:

- ❶ **Unscrew the piston-cylinder module from the PG7601 Platform mounting post.** Hold the module by the knurled circumference and rotate it counter-clockwise all the way out until it can be removed from the mounting post.

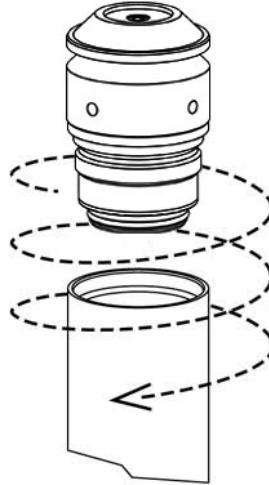


Figure 52. PG7601 piston-cylinder module installation

- ❷ **Install in bullet case.** If the piston-cylinder module is to be stored or shipped, install it in the dark grey, PVC, bullet case in which it was delivered. Thread the module into the base of the case, then install the case cover.

## 6.6.2 INSTALLING THE PISTON-CYLINDER MODULE

To install the piston-cylinder module into the PG7601 Platform mounting post, the AMH automated mass handler and mass set must NOT be installed.

To install the piston-cylinder module into the PG7601 Platform, proceed as follows:

- ❶ **Remove the PG7601 Platform mounting post plug.** If it is present, unscrew the ORANGE plastic mounting post plug that is installed in the PG7601 Platform mounting post. Rotate counterclockwise to remove.
- ❷ **Remove the piston-cylinder module from its bullet case.** Open the piston-cylinder module bullet case by rotating its lid counterclockwise. Remove the piston-cylinder module from the bullet case base by unthreading it from the case. Hold the piston-cylinder module body by the knurled area and rotate it counterclockwise.
- ❸ **Place the piston-cylinder module in the PG7601 Platform mounting post.** Lubricate the module threads very lightly with the Krytox grease supplied with the PG7601 accessories. Place the piston-cylinder module (thread down) into the PG7601 Platform mounting post (see Figure 52).
- ❹ **Screw the piston-cylinder module into the PG7601 Platform mounting post.** Rotate the piston-cylinder module clockwise until all threads are engaged and there is NO gap between the piston-cylinder module and the PG7601 mounting post. Slight resistance will be encountered in the second half of travel as the piston-cylinder module O-rings seat in the mounting post.



*Low torque rotation by hand is all that should be required to fully seat the piston-cylinder module into the PG7601 mounting post. Never force the piston-cylinder module into the mounting post.*



## 6.6.3 DISASSEMBLING THE MODULE AND CLEANING THE PISTON-CYLINDER ASSEMBLY

### 6.6.3.1 OVERVIEW

The PG7601 piston-cylinder module is a high precision metrological assembly. The annular gap between the piston and the cylinder is adjusted to be less than 1 micron. In normal operation, the test gas. If the space becomes contaminated, usually due to foreign matter carried by the pressurized medium, PG7601 performance can be affected. Symptoms of contamination of the space (a **dirty** piston-cylinder) include:

- **Difficulty rotating piston:** The motorized rotation system is unable to start piston rotation.
- **Decay in rotation rate is more rapid than normal:** Piston rotation slows down too quickly, especially at low mass loads.
- **Poor sensitivity:** Very small mass changes do not have the usual effect.
- **Noisy pressure:** The pressure defined when the piston is floating is not a stable as it usually is.

If any of these symptoms are present, they **may** be caused by a **dirty** piston-cylinder. The piston-cylinder module should be disassembled and the piston-cylinder cleaned.



*If symptoms of contamination develop rapidly with operation after cleaning the piston-cylinder module, there is almost certainly a source of contamination within the ADCS-601-AF system. This source must be identified and eliminated to reduce piston-cylinder cleaning frequency. Very often, the source of contamination is the test gas supply itself (which contains humidity or lubricating oil) or it is the return from unclean gas operated DUTs that are connected to the system.*

---

### 6.6.3.2 DISASSEMBLING AND REASSEMBLING THE MODULE



*The PG7601 piston-cylinder module design affords maximum protection to the piston-cylinder element assuring that it is protected during routine piston-cylinder handling. Cleaning the piston-cylinder requires disassembly of the module and exposure of the piston-cylinder to possible damage. These risks include damage to the critical working surfaces for all piston-cylinder sizes and chipping or breaking. Only qualified personnel should undertake piston-cylinder disassembly and reassembly and the instructions and recommendations contained in this manual should be followed carefully throughout the operation.*

---



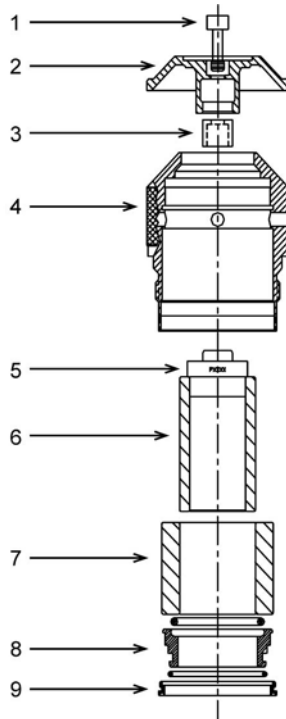
*NEVER touch the lapped surfaces (polished appearance) of the piston or cylinder with your bare hands. Body oils and acids can permanently etch the surfaces.*

---





The piston assembly (piston + piston head + adjusting mass + piston cap + piston cap retaining screw) is part of the mass load. Its mass has been measured and is reported in the calibration report. Use caution when handling these parts, to avoid changing their mass by swapping parts, contaminating them or leaving parts out in reassembly. Out of tolerance pressure definitions could result.



**Figure 53.** 10 kPa/kg gas piston-cylinder module, expanded view

To disassemble the piston-cylinder module it must first be removed from the PG7601 Platform (see Section 6.6.1)

- ❶ Place the piston-cylinder module upside down on a clean stable surface (piston cap (2) down).
- ❷ Using the sleeve nut tool (see Figure 55), remove the sleeve nut (9). The sleeve nut tool is a spanner that fits into the two holes on the sleeve nut.



The 10 kPa/kg sleeve nut has a left hand thread so it is loosened by turning it clockwise.

- ❸ Remove the O-ring assembly (8). Then, being sure to support the cylinder (7) so it doesn't fall out, turn over the remaining assembly so that the piston cap (2) is up.

- ❹ While firmly holding down the cap (2), use a 5 mm Allen tool, to loosen the socket head cap retaining screw (1). The cap retaining screw will not fully disengage from the piston cap due to the adjustment mass (3). Gently remove the cap and screw from the assembly.



When installing the piston cap during reassembly, remember to reinstall the adjustment mass (3).

- ❺ Remove the main module housing (4) by sliding it upward leaving the piston-cylinder assembly behind.
- ❻ Reinstall the piston cap (2) directly onto the piston head (5).
- ❼ Place the 10 kPa/kg piston insertion tool (see Figure 54) on the work surface with the large diameter down.
- ❽ Holding the cylinder (7) to prevent it from falling out, place the piston-cylinder assembly onto the tool sliding the hollowed end of the piston (6) onto the tool shaft. Carefully allow the cylinder to drop down over the large diameter of the tool. Holding the cylinder, gently remove the piston (6) from the tool. Finally, remove the tool from the cylinder.



When reassembling, lubricate the piston-cylinder module parts following the instructions in Section 6.6.3.3..



The orientation of the piston on the cylinder is important. The end of the cylinder that is marked with the serial number should go into the sleeve and/or main module housing first. The piston enters the end of the cylinder that is marked with the serial number. Installing the cylinder with the wrong orientation may lead to out of tolerance measurements.

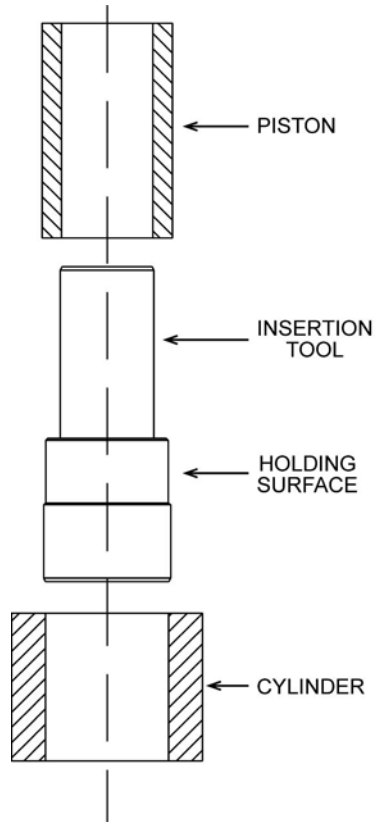


Figure 54. 10 kPa/kg piston insertion tool

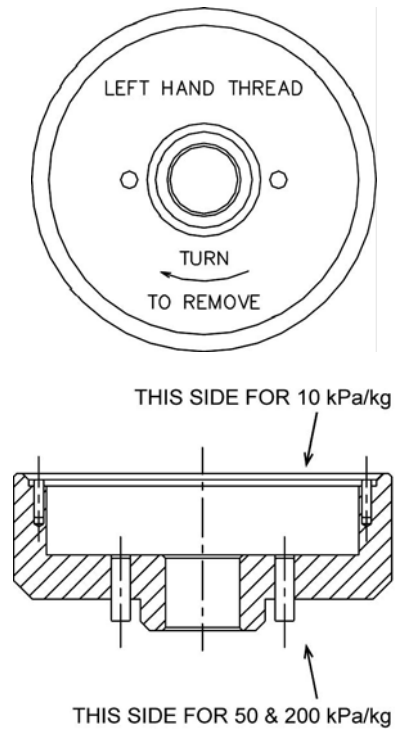


Figure 55. 10 kPa/kg gas piston-cylinder module sleeve nut tool

### 6.6.3.3 LUBRICATING THE PISTON-CYLINDER MODULE

The purpose of piston-cylinder module lubrication is to minimize wear to its components. The proper long term functioning of the module requires that specific areas of certain components be properly lubricated, especially after they have been cleaned.

#### **Lubricant**

Vacuum Grease: DuPont Krytox GPL-205/6 is the recommended lubricant. Krytox is selected because it is a non-reactive, nonflammable, oxygen service safe grease. Very small amounts are used. Krytox is made of perfluoropolyether (PFPE) thickened with polytetrafluoroethylene (PTFE). Users should avoid contact with eyes and skin.

A tube of Krytox GPL-205/6 is included in the PG7601 Platform accessory kit.

#### **Where to Lubricate**

The lubrication chart in Figure 56 depicts the areas that require application of vacuum grease. A thin film (i.e. just enough lubricant to fully cover the area indicated) applied to these areas is all that is necessary. Lubrication with more than a thin film will increase the cost of lubrication and may result in contamination of the piston and/or cylinder. Areas not indicated for lubrication should be kept free from vacuum grease.

#### **Lubricating O-Rings**

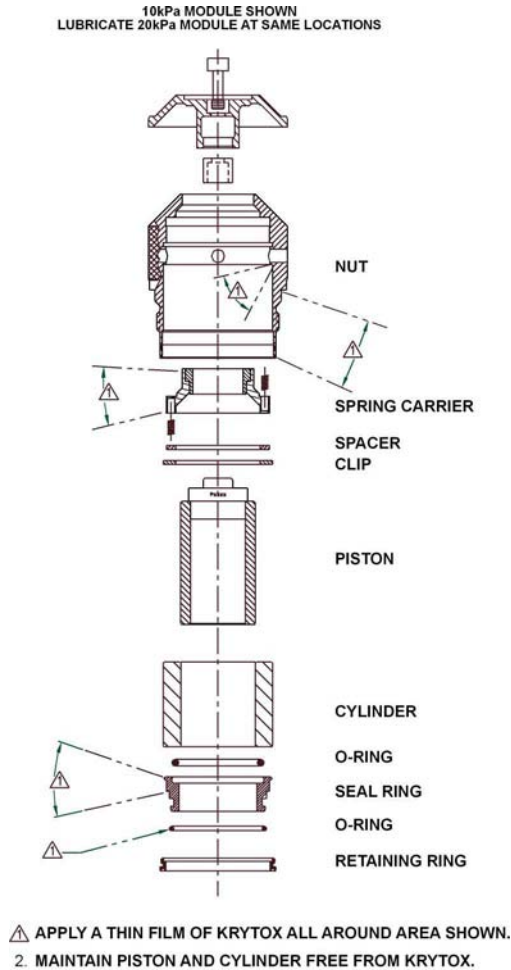
O-rings identified for lubrication should be lubricated prior to installation. During service O-rings may be left in place and a thin film of vacuum grease applied to the outside diameter. Vacuum grease may be applied by placing a drop (3-4mm diameter - approximately 15-30mg) of grease between the thumb and forefinger and then rolling the O-ring between the thumb and forefinger to apply a thin film over the entire o-ring (use of gloves is recommended). An alternate method is to place a drop (3-4mm diameter - approximately 15-30mg) of vacuum grease in a small zip closure plastic bag (just large enough to fit the largest O-ring). Place the O-ring in the bag, close the bag, and then gently work the vacuum grease over the entire O-ring.

#### **Spring Carrier Lubrication**

The spring carrier is lubricated at **DHI**. Under normal conditions it is not necessary for the user to remove the spring carrier for lubrication. In the event that lubrication is necessary, use caution during disassembly. Remove the clip, spacer, spring carrier and springs (qty 6). Lubricate the spring carrier as shown in the lubrication chart. Reassemble, using care to install the springs, spacer and clip in the reverse order of disassembly.

#### **Pistons and Cylinders**

Pistons and cylinders should be kept free from vacuum grease and any other contaminant. Vacuum grease or other contaminants on the piston or cylinder will adversely affect the piston-cylinder module's performance.



**Figure 56.** 10 kPa/kg piston-cylinder module lubrication chart

### 6.6.3.4 CLEANING THE PISTON-CYLINDER

To clean the piston-cylinder, the piston-cylinder module must first be disassembled (see Section 6.6.3.2).



*DO NOT undertake piston-cylinder module disassembly without familiarizing yourself with Section 6.6.3.2 of this manual. Incorrect disassembly may damage or destroy the piston-cylinder element.*

There are two recommended piston-cylinder cleaning methods. Use the one with which you have most success.

#### Water/Detergent Method



*Of the two cleaning methods, the water/detergent method is more time consuming but it is also more thorough.*

- ❶ Disassemble the piston-cylinder module following the instructions given in Section 6.6.3.2.

- ② Reinsert the piston (with cap installed) into the cylinder.
- ③ Create a bath of water and mild liquid dishwashing detergent. Distilled water is acceptable. De-ionized water is best. Detergent must be free of additives (i.e., must not contain lotions or softening agents which may leave a residue after cleaning). To avoid undesired thermal effects, bring the bath to room temperature.
- ④ Holding the piston-cylinder assembly by the outside of the cylinder and the piston cap, submerge the assembly in the bath. Using a rotating motion, thoroughly work the detergent into the piston-cylinder assembly.
- ⑤ With the piston-cylinder still assembled, thoroughly rinse the assembly in a bath of water only. Use the same rotating motion as in the previous step.
- ⑥ Remove the piston from the cylinder and thoroughly dry all areas of the assembly using a lint free towel. DO NOT touch the critical lapped surfaces of the piston or the cylinder with anything other than the drying towel. Only use one side of the towel during this process as the other side will become contaminated by contact with the operator's hands. Do not **buff** the assembly. Just dry it thoroughly.
- ⑦ Reassemble the metrological assembly in reverse order.
- ⑧ If the assembly temperature was elevated during cleaning, it may be necessary to wait to allow the temperature of the assembly to return to ambient temperature before the assembly will operate normally.

### Glass Cleaner Method

---



*Of the two cleaning methods, the glass cleaner method is quicker and less demanding but it is less thorough.*

---



*DO NOT undertake piston-cylinder module disassembly without familiarizing yourself with Section 6.6.3.2 of this manual. Incorrect disassembly may damage or destroy the piston-cylinder.*

---

- ① Disassemble the piston-cylinder module following the instructions given in Section 6.6.3.2.
- ② If you have not already done so, reinstall the cap on the piston.
- ③ Apply a small amount of glass cleaner to a lint free towel. To help ensure that no residue from the glass cleaner will be left behind, slightly dilute the cleaner using distilled or de-ionized water. Wipe the lapped surfaces (polished appearance) of both the piston and cylinder. Do not vigorously **buff** the surfaces.
- ④ Using a separate, clean, lint free towel, wipe the surfaces again to remove any remaining moisture. Do not vigorously **buff** the surfaces.
- ⑤ Reassemble the piston-cylinder assembly in reverse order.

## 6.7 PG7601, PISTON POSITION DETECTION ADJUSTMENT

The PG7601 piston position detection system is used to determine the position of the PG7601's piston within its stroke. If the piston position detection system is out of adjustment, the piston may not be floating freely when expected. This will cause erratic pressure control and unstable and incorrect pressure at the set point.

---



Refer to piston stroke schematic Figure 57.

---

To automatically adjust the PG7601 piston position indication system, proceed as follows:

- 1 Prepare the ADCS-601-AF system for local operation of individual components:

Vent the ADCS-601-AF system by pressing the **[VENT]** button on the **ADCS Run Screen**. Wait for the operation to complete.

Disconnect any device that is connected to the **TEST(+)** port at the port and plug the port using the plug provided.

Press the **[Pause]** button on the **ADCS Main Tool Bar** to suspend remote communication within the ADCS-601-AF system.

- 2 Press the **[ESC]** key on the PG7000 Terminal and on the PG7601's PPC3 Pressure Controller (PPC3-700K) to allow local control.
- 3 Load all the binary masses on the PG7601: On the PG7800 Terminal, press **[SPECIAL]**, **<8AMH>**, **<2control>**, **<2discreet>**. Use the arrow keys to move the cursor and select all the binary masses. Press **[JSETUP]** next to each value (**<1>**, **<2>**, **<4>**...**<64>**) so that there is a **<\*>** next to each value. Enter **<0>** for **<Main:>**. Then press **[ENT]** to cause all the binary masses to load.
- 4 Run the PG7601 piston position calibration function:

Press **[ESC]** on the PG7000 Terminal until operation returns to the main run screen.

Press **[SPECIAL]**, **<7cal>**, **<5Pposition>**, **<2cal>**.

When the prompt **<Hold piston at max down stop>** appears, press **[ENT]**. The piston is already at the down stop because the pressure under the piston is vented and 7.2 kg of mass is loaded.

When the prompt **<Hold piston at max up stop>** appears, go to the PG7601's PPC3 pressure controller (PPC3-700K) and set a pressure of 200 kPa. Press **[ENT]** on the PPC3 front panel, enter 200 kPa (or equivalent in current pressure unit of measure) and press **[ENT]**. Observe the PPC3 display until the pressure reaches approximately 200 kPa. Press **[ESC]**. The pressure may then drop a bit but should hold above 175 kPa. Go back to the PG7000 Terminal and press **[ENT]**. When **<Save new cal>** appears, select **<2yes>**.

- 5 If desired, check the calibration. Select **[SPECIAL]**, **<7cal>**, **<5Pposition>**, **<1view>**. View the position of the piston. When the piston is at the upper stop (pressure of 200 kPa with current mass load) piston position indication should be +4.5 mm. When the piston is at the bottom stop (pressure vented with current mass load) piston position indication should be -4.5 mm. If this is not the case, repeat the calibration process.
- 6 Resume normal ADCS-601-AF operation:

Press **[ESC]** on the PG7601 until its main run screen appears.

Press **[VENT]** on the PPC3 and wait for vent to complete.

Press **[PAUSE]** on the **ADCS Main Tool Bar** to resume normal ADCS-601-AF system operation.

---

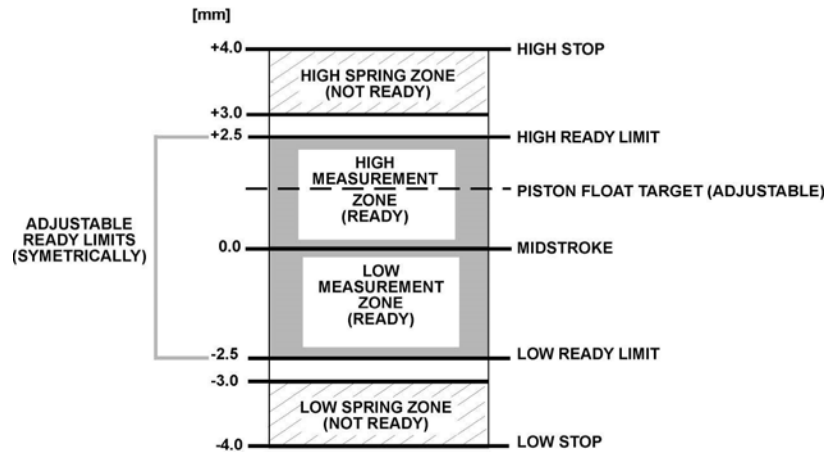


Figure 57. PG7601 piston stroke and zones

## 6.8 PG7601, REPLACE PISTON ROTATION DRIVE BELTS

Periodic replacement of the drive system belts may be necessary to retain maximum performance of the motorized piston rotation system. Due to specific material properties of the drive belts, it is important that only genuine **DHI** replacement parts be used.



*A spare drive belt is included in the accessories delivered with the PG7601 Platform.*

To replace the drive belts it is necessary to access the PG7601 platform. This requires removing the AMH-38 automated mass handler and mass set. See Section 6.5 for instructions.

To remove the drive belts:

- ① Using a 2.5 mm Allen tool, remove the three screws on the outer diameter of the circular black pulley plate that is at the bottom of the platform mounting post. **Do not remove the screws on the inner diameter.**
- ② Remove the two drive belts and replace them with the new ones.
- ③ Realign the notched pulley with the pins on the drive motor.
- ④ Replace the pulley plate and three screws.
- ⑤ Engage the drive system to ensure proper operation.

## 6.9 PG7601, ADJUST INTERNAL VACUUM GAUGE

The PG7601 Platform has an internal Piranni type vacuum gauge. This gauge is used only as an indicator to determine when residual vacuum under the PG7601 bell jar is low enough to open the isolation valve of the PG7601's reference vacuum CDG.

PG7601 internal Piranni gauge should be adjusted occasionally to agree with the CDG to assure proper operation of the CDG isolation valve opening and closing routine. **ADCS Tools** supports automated adjustment of the Piranni gauge.

To adjust the PG7601 internal Piranni gauge proceed as follows:

- ❶ Put the ADCS-601-AF into absolute measurement using the **[Measurement Mode]** button on the **ADCS Run Screen Toolbar** (see Section 4.3.5.3). Wait for the measurement mode change to complete.
- ❷ Press **[Maintenance]** on the **ADCS Tools Main Menu** and select **[Run PG Internal Vac Adjust]**. The adjustment completes automatically in a few seconds.

## 6.10 PG7601/FPG8601, ADJUST PPC3 PRESSURE CONTROLLERS

The PPC3 pressure controllers that control pressure for the PG7601 and the FPG8601 pressure standard systems have internal pressure transducers. The drift over time of the pressure transducers may cause them to disagree excessively with the PG7601 or FPG8601 which reduces the efficiency of the pressure control routines. **ADCS Tools** supports automated adjustment of the PPC3 pressure transducers.

There are three PPC3 pressure transducers: an A700K (700 kPa absolute full scale), an A116K (116 kPa absolute full scale) and a BG15K (15 kPa gauge full scale).

To adjust the PPC3 A700K or A116K transducer:

- ❶ Put the ADCS-601-AF into absolute measurement mode using the **[Measurement Mode]** button on the **ADCS Run Screen Toolbar**. Wait for the measurement mode change to complete.
- ❷ Press **[Maintenance]** on the **ADCS Tools Main Menu** and select **[Run PG-PPC3 Adjust]** or **[Run FPG-PPC3 Adjust]**.
- ❸ View the **[PPC Adjustment Setup]** form. This form is identical to the **[FPG Validation Setup]** form (see Section 7.2.3.2). Edit if desired. Recommended (default) values are the same as FPG validation but the recommended pressure points are:  
For the A116K transducer of the FPG PPC3: 1, 7, 11, 15 kPa or their equivalent.  
For the A700K transducer of the PG PPC3: 20, 150, 250, 375 kPa or their equivalent.

To adjust the PPC3 BG15K:

- ❶ Put the ADCS-601-AF into gauge measurement mode using the **[Measurement Mode]** button on the **ADCS Run Screen Toolbar**. Wait for the measurement mode change to complete.
- ❷ Press **[Maintenance]** on the **ADCS Tools Main Menu** and select **[Run FPG-PPC3 Adjust]**.
- ❸ View the **[PPC Adjustment Setup]** form. This form is identical to the **[FPG Validation Setup]** form (see Section 7.2.3.2). Edit if desired. Recommended (default) values are the same as FPG validation but the recommended pressure points are 1, 7, 11, 15 kPa or their equivalent.



*The PPC3 adjustment routine will cause the ADCS-601-AF to set pressures. The set pressures will be applied to the TEST(+) port. Before running the adjustment routine, be sure any device connected to the TEST(+) port that will not be able to handle a pressure in the ADCS-601-AF range. If nothing is connected to the TEST(+) port it should be plugged with the plug provided.*

---



*The RPM4 A116K internal transducer is adjusted in the FPG8601 validation (see Section 7.2.3.2).*

---



## 6.11 CONTROL CABINET, INTERRUPTING PRESSURE SUPPLY TO THE TEST GAS SUPPLY PORT

To protect the FPG8601 from reverse flow in the lubrication circuit, pressure supply to the FPG8601 lubrication circuit must be higher than the pressure in the lubrication circuit at all times. Before pressure supply to the Control Cabinet **TEST GAS SUPPLY** port is interrupted, the following procedure must be followed to avoid reverse flow:

- ❶ Set gauge measurement mode using the **[MODE]** button on the **ADCS Run Screen Toolbar** (see Section 4.3.5.3). Wait for the process to complete.
- ❷ Shut down the FPG8601 system by pressing the **[OFF]** button on the **ADCS Tools FPG Run Screen** (see Section 4.3.5.3). Wait until the shut down procedure is complete (FPG Pressure is < --- **SHUTDOWN** --- > and indicates *Ready*, see Section 4.1.1).
- ❸ The **TEST GAS SUPPLY** pressure may now be interrupted. **DO NOT REMOVE ELECTRICAL POWER FROM THE FPG8601.**

Once the pressure supply to the **TEST GAS SUPPLY** port has been reestablished, the FPG8601 can be started again by pressing the **[ON]** button on the **ADCS Tools FPG Run Screen**.

## 6.12 CONTROL CABINET, DRAIN DRIVE AIR TRAPS

The ADCS-601-AF Control Cabinet contains two traps to clean the drive air that is supplied to the ADCS-601-AF system (see Figure 10). These should be emptied regularly.

The traps can be emptied without removing pressure. To empty the traps proceed as follows.

- ❶ Open the door on the front of the ADCS-601-AF Control Cabinet.
- ❷ Hold an absorbent towel directly under the trap against its bottom tip and briefly open the trap by turning the butterfly tab at the bottom of the trap on the right..

## 6.13 CONTROL CABINET, CHECK GAS SUPPLY PANEL SETTINGS

The settings of Gas Supply Panel regulators can be viewed on the analog gauges on the gas supply panel (see Figure 10). To access the Gas Supply Panel, open the door on the bottom of the Control Cabinet (see Section 2.1.2).

The regulators settings are fixed by lock nuts. To adjust the regulator, loosen the lock nut then use a screwdriver to turn the regulator stem.

The Gas Supply Panel settings are specified in Table 20.

**Table 20.** Gas Supply Panel pressure settings

REGULATOR	SET POINT [kPa (psi)]
AMH Drive	275 (40)
Valve Drive	600 (87)
FPG Lubrication	300 (45)
PG Controller Supply	450 (65)
FPG Controller Supply	85 (12)

## NOTES

# 7. MAINTENANCE OF TRACEABILITY AND RECALIBRATION

## 7.1 PRINCIPLES OF ADCS-601-AF TRACEABILITY MAINTENANCE

The ADCS-601-AF system is designed to provide state of the art measurement uncertainty specifications with a very high degree of confidence over time while minimizing maintenance requirements.

The maintenance of traceability and associated recalibration of the ADCS-601-AF system requires metrological maintenance procedures that are performed locally at regular intervals (see Section 7.2) and the regular recalibration of certain system elements (see Section 7.3).

ADCS-601-AF is made up of two pressure standards, a PG7601 piston gauge for the majority of the range and an FPG8601 force balanced piston gauge for the low end. The fact that ADCS-601-AF includes two independent pressure standards is exploited to reduce recalibration requirements. The two standards have ranges that overlap between 10 and 15 kPa (3 and 4.5 inHg).

The PG7601 measurement uncertainty is predominantly dependent upon the uncertainty in the effective area of its piston-cylinder and the value of the masses that are loaded on the piston-cylinder (see Section 2.2.1). The FPG8601 measurement uncertainty is predominantly dependent upon the effective area of its piston-cylinder, the value of its internal calibration mass and the linearity and repeatability of its force balanced load cell (see Section 2.2.2).

In the air data range of 1 to 15 kPa (0.3 to 4.5 inHg) that is covered by the FPG8601 in the ADCS-601-AF system, the typical pressure measurement uncertainty of the FPG8601 (see the most recent revision of DHI Technical Note 2090TN05) is much lower than is required to maintain an adequate uncertainty ratio with modern Air Data Test Sets (ADTS). For use in the ADCS-601-AF system, the FPG8601 measurement uncertainty specification is significantly expanded from its typical measurement uncertainty to allow it to be validated within the ADCS-601-AF system and its calibration interval to be indefinite. When the internal ADCS-601-AF validation procedures determine a possible out of tolerance condition of the FPG8601 it is considered to have failed and to require repair.

## 7.2 LOCAL METROLOGY MAINTENANCE BETWEEN RECALIBRATIONS

### 7.2.1 OVERVIEW

To assure that the ADCS-601-AF operates within pressure measurement uncertainty limits between recalibrations, certain metrology maintenance functions are required. These are summarized in Table 21, including cross-reference to manual sections detailing each procedure.

Table 21. Metrological maintenance procedures

SYSTEM	PROCEDURE	DESCRIPTION	FREQUENCY	SEE SECTION
FPG8601	Zero load cell	Fully automated routine that corrects zero drift of the load cell.	Set to perform automatically by <b>ADCS Tools</b> each time the FPG8601 is used. After measurement mode (gauge, absolute) change; at the start of a test; when recommended by FPG Validation	7.2.2
FPG8601	Calibrate load cell span	Fully automated routine that calibrates the span of the load cell using an FPG8601 on-board reference mass.	Set to perform automatically by <b>ADCS Tools</b> when FPG8601 is used. If recommended by validation with PG7601	7.2.2
FPG8601	Validate with PG7601	Fully automated routine that compares the FPG8601 to the PG7601 to verify the FPG8601.	Weekly; after calibration of PG7601; after repair/calibration of FPG8601	7.2.3
FPG8601	Check on-board P, T, H values	Verification that FPG8601 lubrication pressure, temperature and humidity sensors and piston-cylinder temperature values are within expected range.	Weekly; If recommended by validation with PG7601	7.2.3.3
FPG8601	Validate load cell linearity	Verification of load cell linearity by loading it with calibrated masses.	If recommended by validation with PG7601	7.2.5
FPG8601, PG7601	Zero reference vacuum CDGs	Mount CDGs directly on reference vacuum cross, pull down to hard vacuum, compare to a reference (ion gauge) and adjust zero reading as needed.	Monthly until decreased frequency justified by experience	7.2.6
PG7601	Adjust on-board P, T, H sensors	Verify PG7601 Platform ambient pressure, temperature and humidity sensor readings relative to a standard and adjust if necessary.	6 months, increase to 1 year when justified by experience	7.2.7

## 7.2.2 FPG8601, ZERO AND ADJUST SPAN OF LOAD CELL

The FPG8601 uses a precision load cell to measure the force resulting from the pressure across its piston-cylinder. The load cell zero may drift with time and ambient condition changes. The span also may drift, but to a much lesser extent. For this reason, it is necessary to zero and span the load cell regularly. Since the zeroing and span adjustment of the load cell can be performed automatically by the system, transparently to the operator, they do not normally require any special scheduling or procedure (see Section 7.2.2.1). If desired they may also be initiated by the operator (see Section 7.2.2.2).



For additional information on the FPG8601 load cell and the load cell zeroing and spanning functions, see the FPG8601 Operation and Maintenance Manual.

### 7.2.2.1 AUTOMATICALLY INITIATED LOAD CELL ZERO AND SPAN ADJUSTMENT

**ADCS Tools** can be set to zero and adjust the span of the FPG8601 load cell automatically as part of regular ADCS-601-AF operation. This is the default setting and recommended procedure.

**ADCS Tools, [Maintenance], [FPG Cal Options]** provides options concerning when the FPG8601 load cell should be zeroed and spanned automatically. The default is for the process to occur prior to use each time the FPG8601 is activated. This assures that the FPG8601 load cell is always properly adjusted before it is used but it adds 40 to 60 seconds to the first pressure point performed with the FPG8601. To avoid this delay, if the FPG8601 is used regularly, change the **[Maintenance], [FPG Cal Options]** to **<Zero FPG when isolated>**, keeping **<Run FPG internal calibration on each FPG zero>**.



Figure 58. ADCS Tools FPG Run Screen

### 7.2.2.2 OPERATOR INITIATED LOAD CELL ZERO AND SPAN ADJUSTMENT

The ADCS-601-AF operator can initiate an FPG8601 load cell zeroing and/or span adjustment process. To avoid interfering with ADCS-601-AF operation, this should be done when the FPG8601 is **NOT** the active pressure standard (see Section 4.1.3). To zero or span the FPG8601 load cell, expand the **ADCS Tools FPG Run Screen** by pressing the **[FPG]** button on the **Main Toolbar** (see Section 4.3.6.2). In the **FPG Run Screen**, the **[Zero FPG]** and **[Calibrate FPG]** buttons can be used to initiate these activities.

## 7.2.3 FPG8601, VALIDATE WITH PG7601

### 7.2.3.1 OVERVIEW

The overlapping range and high uncertainty ratio of the FPG8601 and PG7601 pressure standards allow the FPG8601 to be validated by comparison with the PG7601. The validation process is performed automatically by **ADCS Tools**.

The validation can be run in absolute or gauge measurement mode. The absolute mode validates the complete system including the reference vacuum CDGs. Gauge mode validation can also be used to check gauge mode only, if desired.

The validation routine compares the PG7601 and FPG8601 at pressures across their overlapping ranges and logs the results. The comparison is made using a high precision pressure monitor (RPM4 A100K) as a comparison standard to avoid the practical difficulties of automating a direct comparison between the FPG8601 and the PG7601. At the end of the test, a pass/fail indication is given. A data file with validation results can be viewed and a report can be generated.

See Section 7.2.3.2 for instructions on running the FPG8601 validation and viewing results.

**<FAIL>** in the **FPG Validation Results Screen** (see Section 7.2.3.2) indicates that the FPG8601 pressure standard may be out of tolerance or there is a problem with another component of the ADCS-601-AF system. Troubleshooting should be

performed to determine the cause of the failure and correct it. Corrective actions to address an FPG8601 validation failure include, in normal order of execution:

- Enter the correct value of local gravity at the site of use in **ADCS Tools** (see Section 3.4.5).
- Assure that the FPG8601 load cell is zeroed and spanned properly before the test (see Section 7.2.2).
- Assure there are no leaks in the system. Disconnect any DUT that may have been connected to the **TEST(+)** port and plug the port using the plug provided. Observe the drop rate of the PG7601 piston gauge when it is floating at a set point and check that the fall rate is normal.
- Check stability of FPG8601 readout at zero (bypassed). The FPG8601 can be put into the bypass position by pressing the **[VENT]** button on the **ADCS Run Screen Toolbar** in absolute or gauge measurement mode. Check the value of **<N>** on the **FPG Run Screen** (see Section 4.3.6.2). This value should be stable within  $\pm 2$ . If it is not, the FPG8601 piston-cylinder may need to be manipulated or cleaned (see Section 6.3).
- Check the FPG8601 P, T, H indications (see Section 7.2.3.3).
- Check the FPG8601 bubbler water supply (see Section 6.2).
- Zero the PG7601 and FPG8601 reference vacuum CDGs (see Section 7.2.6).
- Validate load cell linearity with the FPG8601 mass set (see Section 7.2.5)

If the FPG Validation test is not able to result in a **<PASS>** condition after all corrective actions, the FPG8601 and/or other components of the ADCS-601-AF system require service and **DHI** Authorized Service Provider should be contacted (see Section 9.3).

### 7.2.3.2 RUNNING VALIDATION

To run the FPG8601 validation proceed as follows (the complete process typically requires 20 to 30 minutes using the default validation setup):

- ❶ Prepare the ADCS-601-AF:

Vent the ADCS-601-AF system by pressing the **[VENT]** button on the **ADCS Run Screen Toolbar**. Wait for the operation to complete.

Disconnect any device that is connected to the **TEST(+)** port at the port and plug the port using the plug quick connector stem provided.

Put the ADCS-601-AF system into the measurement mode in which the validation is to be run (see Section 4.2.3). **The absolute mode validation is used to fully verify the system and is the default mode for FPG Validation.**

- ❷ In **ADCS Tools** press **[Maintenance]**, **[Run FPG Validation]**

- ❸ View the **[Validation Setup]** form (see Figure 59). Edit if desired. Recommended (default) values are:

**<Zero FPG before each validation cycle>**: Box checked to zero FPG between each validation cycle.

**<Exercise Pressure>**: Box checked to exercise RPM4 monitor before running validation.

**<Test Point Unit>**: user preference (unit of measure of values in points array).

**<Hold Limit >**: 0.001 kPa or equivalent

**<Dwell Time>**: Timed 45 **<s>**: (Time to dwell at each point before taking data, selecting **<manual>** dwells until the operator presses **[ENTER]**)

**<Averaging Time [s]>**: 30 (Time over which data from the PG and FPG is acquired and averaged at each validation point)

**<Readings Per Point>**: 3 (Individual readings for specified averaging time at each validation point)

**<Validation cycles>**: 1 (Number of times the sequence of pressure points in the point array will be executed. Each cycle results in a separate report)

**<Validation points array>**: 10, 11, 12, 13, 14, 15 kPa or equivalent.

When the form is completed as desired, press **[Continue]**.

- ④ If the **<Exercise Pressure>** box was checked in the **[Validation Setup]** form, the **[Pressure Exercise Setup]** form appears (see Section 4.2.5). The default values of **<Min>**, **<Max>**, **<Dwell>** and **<Cycles>** are 0, 15 kPa (max validation pressure), 120 seconds and 3.
- ⑤ The validation process begins. **ADCS Tools** controls the process, stepping through the points. Watch the **ADCS Tools Status Bar** for information on what is occurring at any given moment.

At each point, the target pressure is set by the PG7601 system onto the RPM4 Monitor and read for the **<Averaging Time>**. An average is taken for the number of **<Readings Per Point>** specified. The RPM4 Monitor is then connected to the FPG8601 system and the process is repeated. The comparison of the PG7601 and FPG8601 is calculated following  $((FPG8601 - RPM4) - (PG7601 - RPM4))$

- ⑥ After the last pressure has completed, the system remains in current condition and the **FPG Validation Results Form** is presented.
- ⑦ View results form (see Figure 60). **<PASS>** or **<FAIL>** is clearly indicated.

**<PASS>** indicates that the FPG8601 pressure standard is in tolerance as verified by comparison with the PG7601 pressure standard (see Section 7.2.3.1).

**<FAIL>** indicates that the FPG8601 pressure standard may be out of tolerance or there is a problem with another component of the ADCS-601-AF system. Troubleshooting should be performed to determine the cause of the failure and correct it (see Section 7.2.3.1).

The **<FPG>** panel indicates the maximum disagreement observed between the FPG8601 and the PG7601 in the test in the current pressure unit of measure  $(FPG8601 \text{ reading} - PG7601 \text{ reading})$  and in PPM  $((FPG8601 \text{ reading} - PG7601 \text{ reading}) / PG7601 \text{ reading}) 1000000$ .

The **<RPM4>** panel indicates the maximum disagreement observed between the RPM4 Pressure Monitor and the PG7601 in the test in the current pressure unit of measure  $(RPM4 \text{ reading} - PG7601 \text{ reading})$ . Pressing the **[Adjust RPM4]** button will cause the RPM4 calibration coefficients to be adjusted to fit its readings with the PG7601 over the range of the comparison. Note: Since the RPM4 is used only as a comparator in the test process, its absolute agreement with the PG7601 is not significant.

**[View Data]** accesses and displays the validation data file with a detailed log of the validation test data.

**[Generate Report]** opens the **Report Editor** to generate a report from the validation data file.

**[Re-Run Validation]** re-runs the validation test immediately.

**[Exit]** closes the **FPG Validation Results Form**.

Figure 59. ADCS Tools FPG Validation Setup Form

Figure 60. ADCS Tools FPG Validation Results Form



### 7.2.3.3 VIEWING FPG VALIDATION DATA

FPG Validation test results can be viewed in a pop-up screen at the end of the test (see Section 7.2.3.2, Figure 60).

The results of FPG Validation tests are also logged in \*.dat files like other automated tests. See Section 4.4.3.3 for additional information on \*.dat files.

The Root Data directory defined in **[Tools]**, **[Test Options]** specifies the file location. The default subdirectories are :

```
\Data\FPGValidation
\Data\FPG-PPC
\Data\PG-PPC
```

### 7.2.4 FPG8601, CHECK ON-BOARD P, T, H MEASUREMENTS

Check that the FPG8601 on-board pressure, temperature and humidity measurements are within their acceptable range. Table 22 lists the measurements and their limits:

The measurement values can be viewed on the **ADCS Tools FPG Run Screen** (see Section 4.3.6.2).

If the temperature value is out of range, the temperature control in the environment in which the ADCS-601-AF is inadequate.

If the lubrication gas pressure is outside of limits, check the adjustment of the **FPG Lubrication** regulator on the Gas Supply Panel in the Control Cabinet (see Section 6.13).

If the lubrication gas relative humidity is out of limits low, check the FPG8601 bubbler for adequate water level (see Section 6.2).

**Table 22.** FPG8601 P, T, H limits

MEASUREMENT	VALUE AND LIMITS
Lubrication gas pressure (gauge mode)	140 kPa abs $\pm$ 8
Lubrication gas pressure (absolute mode)	40 kPa abs $\pm$ 8
Lubrication gas relative humidity	40 to 70 %RH
Mounting post temperature	19 to 27 °C

### 7.2.5 FPG8601, VALIDATE LOAD CELL LINEARITY

#### 7.2.5.1 OVERVIEW

The FPG8601 uses a precision load cell to measure the force resulting from the pressure across its piston-cylinder. In normal operation, the only adjustments to the load cell that are necessary to maintain in tolerance measurements is to zero and span it which can be performed automatically by the ADCS-601-AF system (see Sections 2.2.2, 7.2.2).

The linearity of the load cell is set at the factory and cannot be adjusted by the user. In day to day operation load cell linearity is verified by the combination of the zeroing process and the FPG Validation routine (see Section 7.2.3).

If the linearity problem with the load cell is suspected, it can be verified by loading masses directly onto the load cell throughout its operating range. This allows the load cell to be verified independently of the behavior of the FPG8601 piston-cylinder and without requiring a precision pressure reference.

The load cell linearity verification is performed using the FPG8601 Calibration and Linearization Bracket (CLB) and mass set. The mass set consists of masses of 3 x 500 g, 2 x 200 g, 1 x 100 g.

See Section 7.2.5.2 for the recommended procedure to verify the FPG8601 load cell linearity.

### 7.2.5.2 LINEARITY VERIFICATION PROCEDURE

To verify the FPG8601 load cell linearity proceed as follows:

- ❶ Remove the FPG8601 piston-cylinder following the procedure described in Section 6.3.2.
- ❷ Attach the Calibration and Linearization Bracket (CLB) to the FPG8601 gimbal assembly using the two piston retaining nuts. Verify that the FPG8601 is level.
- ❸ Go to the **ADCS Tools FPG Run Screen** by pressing the **[FPG8601]** button on the **Main Toolbar**.

Zero the FPG8601 using the **[Zero]** button the **FPG Run Screen**.

Record the value of **<N>** after zeroing.

- ❹ Place a second 500 g mass on top of the first 500 g mass. Wait for stabilization and record the value of **<N>**. Note: it is normal for the value of **<N>** not to correspond exactly to the mass loaded.

Repeat mass placement and recording **<N>** until all the masses of the 2 kg mass set have been loaded.

- ❺ Repeat process changing order of placement of masses to include different points in the span as desired (for example, after zeroing, load the 1 x 100 g and 2 x 200 g, rather than the 500 g to check more points in the low end of the span).
- ❻ Evaluate the linearity verification data using the information in Section 7.2.5.3.
- ❼ Remove the masses and CLB from the FPG8601.
- ❽ Reinstall the piston-cylinder and lower mounting post (see Section 6.3.6).

### 7.2.5.3 EVALUATING LINEARITY VERIFICATION DATA

The objective of the linearity evaluation using the CLB and FPG8601 mass set is not to verify the absolute measurement uncertainty of the load cell, only its linearity. Due to relative adjustments to the load cell output to take into consideration local gravity, air density and other factors, it is normal for one measurement count of the FPG8601 load cell not to correspond to a whole number mass value and for the output in counts when a mass is loaded not to agree in the absolute sense with the true value of the mass.

The linearity evaluation can be considered a purely proportional exercise. With a perfectly linear device, if an input of 1 results in an output of x, an input of 2 will result in an output of exactly 2x, etc.

**The linearity tolerance of the load cell is  $\pm$  (2 ppm + 2 counts).**

There are several ways to use the data taken in Section 7.2.5.2 to evaluate the linearity of the load cell. One is to perform a best fit, linear regression of the true mass load and load cell output data and compare the residuals to the linearity tolerance. A simplified method follows:

- 1 Calculate the mass load value corresponding to one count by dividing the number of counts (<N>) by the total true mass loaded since the balance was zeroed. To obtain the total true mass value, add up the true value of all the masses loaded (except the first 500 g that was tared out). The true values of the individual masses can be found in the mass set Calibration Report.

For example:

Total true mass load: 1501.756 g

Counts (<N>) indicated with total true mass load: 1 488 663

Value of 1 count:  $1\ 488\ 663 / 1501.756\ \text{g} = 991.2815\ \text{count/g}$

- 2 Predict the balance output at other mass loads by multiplying the value of 1 count calculated in 1 by the true mass load.

For example:

Total true mass load 500.664 g

Predicted output (<N>):  $500.664\ \text{g} * 991.2815\ \text{count/g} = 545\ 863\ \text{count}$

- 3 Find the difference between the predicted output and the actual output logged when the mass was loaded:

Predicted output (<N>): 545 863 count

Actual output (<N>): 545 862 count

Difference: 1 count

- 4 Compare the difference between the predicted output and the actual output to the linearity tolerance to determine an pass or fail condition.

Difference between the predicted and actual outputs: 1 count

Linearity tolerance:  $\pm (2\ \text{counts} + (2\ \text{ppm} * 454\ 863)) = \pm 3\ \text{counts}$

Pass fail condition: Pass

If the any load cell linearity verification point results in an fail condition, repeat the verification process, including the initial zeroing of the load cell with the CLB and 500 g mass loaded. Be sure the load cell output is stable at each point.

If the load cell linearity verification consistently has one or more fail conditions, the FPG8601 requires factory service. Contact DHI or an DHI Authorized Service Provider (see Table 26).

## 7.2.6 FPG8601 AND PG7601, ZERO REFERENCE VACUUM CDGS

The FPG8601 and PG7601 use independent capacitance diaphragm gauges (CDGs) to measure the reference vacuum pressure in absolute measurement mode.

The CDGs are known to often have significant zero drift that is easily corrected by zeroing their output at a very low vacuum.

The CDGs cannot be zeroed properly in the normal operating position but the ADCS-601-AF includes facilities to easily zero the CDGs on the system. This avoids requiring separate vacuum facilities and offers the convenience of not needing to disconnect the CDGs electrically.

To zero the ADCS-601-AF CDGs proceed as follows:

- 1 Prepare the ADCS-601-AF:

Put the ADCS-601-AF system into gauge mode and wait for the mode change to complete (see Section 4.2.3).

Vent the ADCS-601-AF system by pressing the **[VENT]** button on the **ADCS Run Screen**. Wait for the operation to complete.

The CDGs should be powered continuously for at least 10 hours before they are zeroed. When the ADCS-601-AF system is powered, the CDGs are powered.

- 2 In **ADCS Tools** press **[Maintenance]**, **[Run CDG Zero]**. A message instructing you to set up the ADCS-601-AF hardware is presented. Set up the hardware following steps 3 through 7.

- 3 Setup the ADCS-601-AF vacuum manifold for CDG zeroing.

Remove the vacuum clamps and the top cap-off from the KF40 cross between the PG7601 and FPG8601 pressure standards.



- 4 Remove the KF40 cross. Push the KF40 bellows connection on the FPG8601 to provide clearance for the KF40 centering rings to clear the fittings.



- 5 Rotate the KF40 cross 90° and install it on the vertical tube coming up through the bench from the turbo pump.



- 6 Remove the CDGs from the PG7601 AMH-38 and the FPG8601. Keep them electrically and pneumatically connected.

**CAUTION: DO NOT BREAK THE CONNECTIONS AT THE CDG OR THE CDG WILL BE EXPOSED TO ATMOSPHERE. BE SURE TO BREAK THE CONNECTIONS ON THE SIDE OF THE ISOLATION VALVE THAT IS AWAY FROM THE CDG.**

**PG7601 AMH-38 CDG:** Break the connection at the KF40 vacuum clamp closest to the AMH-38 vacuum chamber so that the KF40 x KF16 adaptor stays with the CDG.

**FPG8601 CDG:** Break the connection at the KF16 connection on the FPG8601 lower mounting post.



- ⑦ Install the CDGs on the two horizontal legs of the KF40 cross so that they are in the same vertical position as in their normal operating position. Use the KF16 x KF40 adaptor provided with the ADCS-601-AF accessories to adapt the FPG8601's CDG assembly from KF16 to KF40.

Install a low vacuum reference on the top of the KF40 cross (a calibration ion gauge is recommended, not included with the ADCS-601-AF system).



- ⑧ Press the **[OK]** button on the **<Setup Verification>** prompt. A second **<Setup Verification>** prompt is presented.

Check all vacuum fittings as requested and press the **[OK]** button. The reference roughing pump and turning pump will activate.

Observe the level of vacuum as indicated by the vacuum reference (ion gauge) and by the rotation rate of the turbo pump displayed on the pump controller. When the vacuum is less than 10 Pa, use the **[OPEN]** buttons on the **ADCS Tools Run Screen** to open the CDG isolation valves, opening the CDGs to the KF40 cross and the pumping system.

Allow the pump the pressure to pull down and stabilize.

- ⑨ Observe the level of vacuum as indicated by the vacuum reference.

Observe CDG readings on the **ADCS Tools CDG Zero Run Screen**. Using the potentiometers on the top of the CDGs, adjust the CDGs to cause their output as indicated on the **ADCS Tools CDG Zero Run Screen** to agree with the value indicated by the vacuum reference (ion gauge) .

- ⑩ Isolate the CDGs from the KF40 cross by pressing the **[Close Valve]** buttons on the **ADCS CDG Zero Run Screen**.

- ⑪ Double check that the CDG isolation valves are **CLOSED** (exposing the CDGs to atmospheric pressure will make it necessary to zero them again).

Bring the KF40 cross pressure back to atmospheric pressure by pressing the **[STOP]** button (top sign) on the **ADCS Main Tool Bar**. Press **[Yes]** In response to the **<Are you sure>** prompt if you are ready to end the CDG zeroing process. This causes the reference vacuum pumps to turn OFF and vent.

Wait for the venting process to complete.

- ⑫ Remove the CDGs from the KF40 cross and return them to their normal operating position.

Reassemble the KF40 cross for normal ADCS-601-AF operation following steps ③ through ⑦ above in reverse order.

Put the ADCS-601-AF in absolute measurement mode (see Section 4.2.3) and verify that the vacuum reference pressure pulls down as expected.

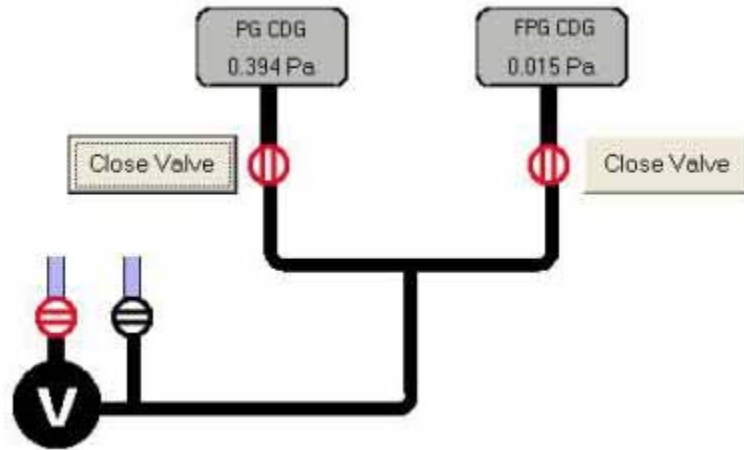


Figure 61. ADCS Tools CDG Zero System Display

## 7.2.7 PG7601, ADJUST ON-BOARD P, T, H SENSORS

The PG7601 Platform includes sensors to measure ambient conditions. The values measured are used to calculate ambient air density which is used to make the air buoyancy correction to the force applied by the PG7601 masses in gauge mode. The measurements of the ambient conditions sensors have no function when the PG7601 is used in absolute measurement mode.

The on-board measurement sensors and their measurement uncertainty tolerances are:

- Barometric pressure sensor,  $\pm 140$  Pa
- Relative humidity sensor,  $\pm 10$  % RH
- Ambient temperature sensor:  $\pm 1$  °C

The ambient conditions sensors are verified and adjusted relative to a reference without being removed from the platform. The measurement uncertainty specification of the on-board sensor should be taken into consideration when selecting a reference relative to which to adjust them.

The sensors are adjusted using **[Maintenance]**, **[PG Sensors]** in **ADCS Tools** (see Figure 62).

The **PG Sensors Adjust** form allows the current output of each sensor to be viewed. Each sensor's output can be adjusted by changing the value of an adder and/or multiplier that are used to offset and adjust the slope of the sensor's output. The adder and multiplier adjust the sensor output as follows:

$$\text{Corrected Output} = (\text{Measured Output} \times \text{Multiplier}) + \text{Adder}$$

Where:

- Corrected output, measured output and adder are in the current unit of measure of the sensor
- Multiplier is dimensionless
- Normally, it is sufficient to offset the sensor's output relative to the reference using the adder only.

	Value	Adder	Multiplier
Ambient Temperature Sensor	25.440 C	0.000	1.000000
Ambient Pressure Sensor	97.480 kPa	0.000	1.000000
Humidity Sensor	38 %RH	0.000	1.000000
Internal Vacuum Reference	0.31 Pa	0.000	1.000000

Last Edit: Saturday, February 12, 2005 2:28:06 PM

Buttons: Save Changes, Re-Load, Close

Figure 62. PG7601 Ambient Sensors Adjust Form

## 7.3 RECALIBRATION

### 7.3.1 OVERVIEW

To assure that the ADCS-601-AF operates within pressure measurement uncertainty limits, certain metrology maintenance functions are required. See Section 7.2 for instructions on these procedures.

In addition to the metrology maintenance functions, to assure that the pressure values set and measured by the ADCS-601-AF remain within predicted measurement uncertainty levels over time, regular recalibration of certain components is required. The recalibrations required are summarized in Table 23, including cross-reference to manual sections detailing each procedure.

Table 23. Recalibration requirements

SYSTEM	PROCEDURE	DESCRIPTION	FREQUENCY	SEE SECTION
PG7601	Calibration of piston-cylinder module	Determination of piston-cylinder effective area and entry of new effective area value into system.	Yearly until decreased frequency justified by experience. Recommended end of first and second years, then every three years if no significant changes observed.	7.3.2
PG7601	Calibration of mass set	Determination of mass values of mass set and piston assembly and entry of new values into the system.	Yearly until decreased frequency justified by experience. Recommended end of first and second years, then every three years if no significant changes observed.	7.3.3
PG7601	Calibration of piston-cylinder temperature sensor.	Determination of offset of reading of platinum resistance thermometer mounted in PG7601 mounting post relative to a temperature standard and entry of new offset into the system.	Yearly until decreased frequency justified by experience. Recommended end of first and second years, then every three years if no significant changes observed.	7.3.4
PG7601	Calibration of reference vacuum CDG	Determination and adjustment of slope of the reference vacuum capacitance diaphragm gauge, power supply and read out.	6 months, increase to 1 year when justified by experience.	7.3.5

SYSTEM	PROCEDURE	DESCRIPTION	FREQUENCY	SEE SECTION
FPG8601	Calibration of linearity verification mass set	Determine and, if necessary, adjust the mass values of the mass set	Yearly until decreased frequency justified by experience. Recommended end of first and second years, then every three years if no significant changes observed.	None
FPG8601	Calibrate and/or repair	Calibration and/or repair by DHI or an Authorized Service Provider of the FPG8601 instrument.	Indefinite, failure of an FPG8601 component, failure of validation by PG7601.	None

## 7.3.2 PG7601, CALIBRATION OF PISTON-CYLINDER MODULE

### 7.3.2.1 PREPARING FOR CALIBRATION

Piston gauge piston-cylinder modules are often calibrated in a facility other than that in which the ADCS-601-AF system is used.

If the calibration facility has PG7601 platform and mass set, it may only be necessary to ship the PG7601 10 kPa/kg piston-cylinder module for calibration. If not, the piston-cylinder module, PG7601 platform and perhaps masses have to be shipped.

To ship the piston-cylinder module it must be removed from the PG7601 platform. See Section 6.3.2 for instructions on removing the piston-cylinder module from the platform and packing it in its bullet case.

If the complete PG7601 system must be shipped, use the unpacking information in Section 3.1 to pack it.

### 7.3.2.2 UPDATING PISTON-CYLINDER CALIBRATION INFORMATION



*Piston-cylinder module information is element specific metrological data. Uninformed or accidental altering of this information may lead to out of tolerance measurements. Piston-cylinder module information should only be edited by qualified personnel as part of the ADCS-601-AF calibration or recalibration process.*

When a piston-cylinder is recalibrated, the results are given in a calibration report.

The calibration report specifies the piston-cylinder effective area and the piston assembly mass determined by the calibration facility. These values may change from calibration to calibration and the new values must be entered into the ADCS-601-AF system so that they are used in its pressure calculations. The characteristics of a piston-cylinder include many other values but these are constant over time. For additional information on PG7601 piston-cylinder characteristics and how they are stored in the PG7601 platform, see the PG7000 Operation and Maintenance Manual.

ADCS Tools has the capability to view or edit the value of the PG7601 10 kPa/kg piston-cylinder's effective area and mass. Use **[Maintenance]**, **[Calibration]**. (see Figure 63). The piston calibration data is displayed and edited on the **[Piston-Cylinder Module]** tab. The piston-cylinder shown is always the ADCS-601-AF PG7601's active piston-cylinder. Check that the correct piston-cylinder module is shown by verifying its serial number against the serial number shown in the panel label. To change the active piston-cylinder use **[Setup]**, **[Configuration]**, **[PG]**.



**To edit the effective area value:** click on the value and enter the desired value. Be sure to enter the value of effective area at 20 °C in mm<sup>2</sup>.

**To edit the mass value:** click on the value and enter the desired value. Be sure to enter the value in kilogram. The average density value is a constant that does not change with calibration. It is reported with the piston-cylinder module's original calibration report.

When all changes are complete, press the **[Save Changes]** button to cause **ADCS Tools** to store the entered values permanently in PG7601 Platform memory.

Use **[Close]** to leave the form without making any changes.

Use **[Reload]** to reload the form with the values that are in the PG7601 Platform memory. This feature can be used to verify the data entered after **[Save Changes]** has been pressed.

Piston-Cylinder   Mass Set	
Piston-Cylinder SN 526	
Effective Area (mm <sup>2</sup> )	380.5151
Mass (kg)	0.5000040
Density (kg/m <sup>3</sup> )	10080.0
Mounting Post PRT SN 398	
Resistance at 0°C (ohms)	100
Slope (ohms/C°)	0.3896
<input type="button" value="Save Changes"/> <input type="button" value="Re-Load"/> <input type="button" value="Close"/>	

**Figure 63.** ADCS Tools PG7601 Piston-Cylinder Calibration Form

## 7.3.3 PG7601, CALIBRATION OF MASS SET

### 7.3.3.1 PREPARING FOR CALIBRATION

Piston gauge mass sets are often calibrated in a facility other than that in which the ADCS-601-AF system is used so calibrating the mass set requires removing it from the PG7601 Platform and shipping it. If the mass set and the piston-cylinder module are to be calibrated by the same facility, they are usually shipped together, with the PG7601 Platform if necessary.

To ship the PG7601's AMH-38 mass set it must be removed from the PG7601 platform. See Section 6.5.2 for instructions on removing the mass set from the platform.

Once the masses have been removed from the PG7601 platform, they should be packed in protective bags in the molded transit cases in which they were delivered. Be sure to include the mass loading bell, the binary mass tray and the mass lifting shaft as they are part of the mass set.

If the complete PG7601 system must be shipped, use the information in Section 3.1 to pack it.

### 7.3.3.2 UPDATING MASS SET CALIBRATION INFORMATION

---



*Mass set information is element specific metrological data. Uninformed or accidental altering of this information may lead to out of tolerance measurements. Mass set information should only be edited by qualified personnel as part of the ADCS-601-AF calibration or recalibration process.*

---

When a mass set is recalibrated, the results are given in a calibration report.

The calibration report lists a value measured by the calibration facility for each mass. These values may change from calibration to calibration and the new values must be entered into the ADCS-601-AF system so that they are used in its pressure calculations. For additional information on PG7601's AMH-38 mass set characteristics and how they are stored in the PG7601 platform, see the PG7000 Operation and Maintenance Manual.

ADCS Tools has the capability to view or edit the value of the PG7601's AMH-38 mass set masses. Use **[Maintenance]**, **[Calibration]**, **[Mass Set]** (see Figure 64). The mass set calibration data is displayed and edited in the **[Mass Bell]** and **[Mass Set]** panels. The mass set and mass bell shown are always the ADCS-601-AF PG7601's active mass bell and mass set. Check that the correct bell and mass set are shown by verifying their serial numbers against the serial numbers shown in the panel labels. To change the active mass bell and mass set use **[Setup]**, **[Configuration]**, **[PG]**.

**To edit the mass bell value:** click on the value and enter the desired value. Be sure to enter the value in kilogram. The average density value is a constant that does not change with calibration. It is reported with the mass set's original calibration report. This value is different from the density value for the rest of the mass set because the mass bell is the assembly of the bell, binary mass tray and mass lifting shaft and some of these parts are made of titanium.

**To edit the value of the masses in the mass set:** click on each value and enter the desired value. Be sure to enter the value in kilogram. The density value is a constant that does not change with calibration. It is reported with the mass set's original calibration report.

When all changes are complete, press the **[Save Changes]** button to cause **ADCS Tools** to store the entered values permanently in PG7601 Platform memory.

Use **[Close]** to leave the form without making any changes.

Use **[Reload]** to reload the form with the values that are in the PG7601 Platform memory. This feature can be used to verify the data entered after **[Save Changes]** has been pressed.

Mass Bell SN 2218	
Mass (kg)	0.4952379
Density (kg/m <sup>3</sup> )	4610.0

Mass Set SN 2218	
Mass Density (kg/m <sup>3</sup> )	8000.0
0.10kg	0.1007337
0.20kg	0.2008764
0.40kg	0.4025216
0.80kg	0.805390
1.60kg	1.606309
3.20kg	3.204629
#1 6.40kg	6.242969
#2 6.40kg	6.248854
#3 6.40kg	6.246356
#4 6.40kg	6.244163
#5 6.40kg	6.243571

Figure 64. ADCS Tools PG7601 AMH-38 Mass Set Calibration Form

## 7.3.4 PG7601, CALIBRATION OF PISTON-CYLINDER MODULE TEMPERATURE SENSOR

### 7.3.4.1 OVERVIEW

The PG7601 Platform uses a platinum resistance thermometer (PRT) embedded in the piston-cylinder mounting post to measure the temperature of piston-cylinder module.

The PRT is a 10052 4-pole type following DIN Norm 43760. The current supplied to the PRT is 1 mA and the slope of resistance relative to temperature over the valid temperature range of 0 to 40 °C is 0.3896 Ω/°C. The uncertainty specification is ± 0.1 °C (± 0.02 Ω) with a resolution of 0.01 °C.

The ohmic measurement system in the PG7601 is self-calibrated using on-board 100 and 110 Ω reference resistors.

The normal calibration procedure of the PRT is to determine its offset relative to ambient temperature relative to a reference. This can be done without removing the PRT from the mounting post if a reference is available that can be inserted in the mounting post pressure bore (see Section 7.3.4.2). The PRT slope, over the limited range of use of 0 to 40 °C, can be considered a physical constant.

Once the offset is determined, it is entered into the system using **ADCS Tools** (see Section 7.3.4.3).

It is possible to remove the PRT from the mounting post if necessary. To remove the PRT from the PG7601 mounting post, follow the instructions provided in Section 6.3.7.

### 7.3.4.2 PROCEDURE

Determining the offset of the PG7601 PRT relative to a reference requires a calibrated temperature probe of adequate uncertainty at ambient temperature (see Section 7.3.4.1) that can be inserted into the PG7601 mounting post pressure bore (6.25 mm (< 1/4 in.) diameter bore).

To determine the offset of the PG7601 PRT relative to a reference, proceed as follows:

- ❶ Remove the PG7601 piston-cylinder module (see Section 6.6.1).
- ❷ Press the **[ESC]** key on the PG7000 Terminal and then select **[SPECIAL]**, **<7cal>**, **<4PCT>**. This provides a display of current mounting post PRT temperature reading, PRT resistance at 0°C and RPT slope.
- ❸ Insert the reference temperature probe (usually a PRT) in the the pressure bore in the PG7601 mounting post (insert vertically, straight down from the top of the mounting post). The mounting post bore diameter is 6.25 mm (< 1/4 in.).
- ❹ Wait 60 minutes for temperature stabilization.
- ❺ Record the reading in °C of the reference temperature probe and the PG7000 Terminal every 15 seconds for 5 minutes. The 5 minutes may be increased to correspond with a temperature cycle of the test environment if the environment has a clear temperature cycle time.
- ❻ Evaluate the results of the readings. If total temperature change of either indication is greater than 0.05°C, the temperature instability is too great and the measurements should be repeated until total temperature change is less than 0.05°C.
- ❼ Resume normal ADCS-601-AF operation:  
Press **[ESC]** on the PG7601 until its main run screen appears.  
Press **[PAUSE]** on the **ADCS Main Tool Bar** to resume normal ADCS-601-AF system operation.

### 7.3.4.3 CALCULATING AND UPDATING PISTON-CYLINDER TEMPERATURE SENSOR INFORMATION

---



*Piston-cylinder mounting post PRT information is element specific metrological data. Uninformed or accidental altering of this information may lead to out of tolerance measurements. Piston-cylinder module PRT information should only be edited by qualified personnel as part of the ADCS-601-AF calibration or recalibration process.*

---

After performing the comparison process described in Section 7.3.4.3, the new PRT offset must be calculated and entered.

#### **Calculating the new PRT offset**

Calculate the new PRT offset as follows:

Using the data obtained in the comparison process described in Section 7.3.4.3, average the readings of the PG7601 PRT and average the readings of the reference temperature probe.

Calculate the difference between the two following:

$$\text{PG7601 avg. temp. [}^\circ\text{C]} - \text{reference avg. temp. [}^\circ\text{C]} = \Delta \text{ avg. temp [}^\circ\text{C]}$$

Calculate the resistance corresponding to  $\Delta$  avg. temp using the slope of the PG7601 PRT following:

$$\Delta \text{ avg. temp [}^\circ\text{C]} \times \text{PRT slope [}\Omega/^\circ\text{C]} = \Delta \text{ resistance [}\Omega\text{]}$$

Calculate the new offset by adding the  $\Delta$  resistance to the previous offset (the previous offset is the previous value of <RZ> in the PG7000 Terminal display or <Resistance at 0 °C> in **ADCS Tools**, [**Maintenance**], [**Calibration**], [**Piston-Cylinder**] (see Figure 65):

$$\text{previous offset [}\Omega\text{]} + \Delta \text{ resistance [}\Omega\text{]} = \text{new offset [}\Omega\text{]}$$

The new offset should be entered into the system following the procedure described below.

### Updating piston-cylinder temperature sensor information

The offset value of the piston-cylinder mounting post platinum resistance thermometer may change from calibration to calibration. The new offset value determined above must be entered into the ADCS-601-AF system so that it is used in its calculations. For additional information on PG7601 characteristics and how they are stored in the PG7601 platform, see the PG7000 Operation and Maintenance Manual.

**ADCS Tools** has the capability to view or edit the value of the PG7601's mounting post PRT offset and slope. Use [**Maintenance**], [**Calibration**], [**Piston-Cylinder**] (see Figure 65). **ADCS Tools** must be ON for the [**Maintenance**] menu to be accessible. The PRT calibration data is displayed and edited in the [**Mounting Post PRT**] panel. Check that the correct PRT is shown by verifying its serial number against the serial number shown in the panel label. To change the active PRT use [**Setup**], [**Configuration**], [**PG**].

Enter the new offset value in by clicking on the value and entering the desired value. The field is labeled <Resistance at 0 °C> as this is a conventional term for platinum resistance thermometers but the resistance at ambient temperature is used as the offset because the RPT is only used in the limited range of 15 to 35 °C.

The slope value is not normally edited as it is a physical constant for the type of PRT used (see Section 7.3.4.1)

When all changes are complete, press the [**Save Changes**] button to cause **ADCS Tools** to store the entered values permanently in PG7601 Platform memory.

Use [**Close**] to leave the form without making any changes.

Use [**Reload**] to reload the form with the values that are in the PG7601 Platform memory. This feature can be used to verify the data entered after [**Save Changes**] has been pressed.

Piston-Cylinder   Mass Set	
Piston-Cylinder SN 526	
Effective Area (mm <sup>2</sup> )	980.5151
Mass (kg)	0.5000040
Density (kg/m <sup>3</sup> )	10080.0
Mounting Post PRT SN 398	
Resistance at 0°C (ohms)	100
Slope (ohms/°C)	0.3896

Save Changes    Re-Load    Close

Figure 65. ADCS Tools PG7601 Piston-Cylinder Calibration Form

## 7.3.5 PG7601, CALIBRATION OF REFERENCE VACUUM CDG

### 7.3.5.1 OVERVIEW

The PG7601 Platform is equipped with a capacitance diaphragm gauge (CDG), power supply and read-out that are used to measure the reference vacuum under the PG7601's bell jar in absolute easurement mode. The capacitance diaphragm gauge should be regularly zeroed (see Section 7.2.6). It should also be calibrated.

To be calibrated, the CDG and its power supply and readout must be removed from the ADCS-601-AF system. See Section 7.3.5.2 for instructions on removing the PG7601 CDG assembly and readout.

The CDG and its power supply/readout are completely autonomous elements whose calibration is independent of ADCS-601-AF. The units should return from calibration adjusted to operate within manufacturer's specifications. No settings in ADCS-601-AF are required when the CDG and supply/readout are reinstalled.

### 7.3.5.2 REMOVING THE CDG ASSEMBLY



The PG7601 CDG includes a vacuum isolation valve to maintain it under vacuum. When connecting or disconnecting the PG7601 CDG from the AMH-38 vacuum chamber, never break the fitting between the valve and the CDG. Always make and break on the other side of the valve so that vacuum is maintained on the CDG at all times.

To remove the PG7601 reference vacuum CDG assembly and power supply/read out, proceed as follows:

- 1 Prepare the ADCS-601-AF for removal of the CDG:

Vent the ADCS-601-AF system by pressing the **[VENT]** button on the **ADCS Run Screen** (see Section 4.2.3). Wait for the operation to complete.

Put the system into gauge mode by pressing the **[MODE]** button on the **ADCS Run Screen**. Wait for the operation to complete.

Press the **[Pause]** button on the **ADCS Main Tool Bar** to suspend remote communication within the ADCS-601-AF system (see Section 4.3.3).

Press the **[ESC]** key on the PG7000 Terminal.

- 2 Remove the CDG:

Disconnect the CDG isolation valve (valve 3) 1/8 in. pneumatic actuation line (**V9**) using the quick connector on the valve.

Disconnect the electrical cable on the top of the CDG.

Break the KF40 fitting on the AMH-38 vacuum chamber or the KF25 fitting on the adaptor. **DO NOT BREAK ANY FITTINGS ON THE CDG SIDE OF THE VALVE.**

- 3 Remove the CDG supply/readout:

Remove the Control Cabinet main rear panel to access the inside of the cabinet.

Reach inside the cabinet to access the panel mount retainer screws on the CDG supply/readout. Loosen the screws and remove the supply/readout.

When shipping the CDG for calibration include the CDG, the supply/readout and the cable that connects the CDG to the supply read/out.

When the CDG and its power supply/readout are received from recalibration, reinstall them onto the PG7601 and into the ADCS-601-AF control cabinet.

## NOTES





## 8. TROUBLESHOOTING

### 8.1 OVERVIEW

ADCS-601-AF is a sophisticated pressure measuring and controlling instrument with advanced on-board features and functions. Before assuming that unexpected behavior is caused by a system defect or breakdown, the operator should use this manual and other training facilities to become thoroughly familiar with ADCS-601-AF operation. This troubleshooting guide is intended as an aid in identifying the cause of unexpected ADCS-601-AF behavior and determining whether the behavior is due to normal operation or an internal or external problem.

Identify the symptom or unexpected behavior you are observing from the **SYMPTOM** list below. A **PROBABLE CAUSE** is provided and a **SOLUTION** is proposed including references to manual sections that provide information that may be of assistance.

**Table 24.** Troubleshooting checklist

SYMPTOM	PROBABLE CAUSE	SOLUTION
PPC3, RPM4 or PG7601 front panel display is dim.	Screen saver option has been activated.	Press any key to resume full screen power, adjust screen saver activation time if desired. Product Operation and Maintenance Manual
Communication with an ADCS component cannot be established.	Computer and/or component interface not correctly configured; incorrect or bad interface cable.	Check and correct interface configurations and cables if necessary. Check interface configuration in <b>ADCS Tools, [Setup], [Configuration]</b> . Run product COM port test. Product Operation and Maintenance Manual.
ADCS component displays <FATAL ERROR> or <FATAL FAULT>.	Component encountered unresolved internal software conflict.	Cycle component power to clear. Record conditions leading up to the event, including the numbers displayed when enter is pressed and report the information to a <b>DHI</b> Authorized Service Provider.
PG7601 displays <TOUT> or <TIME-OUT>.	PG7601 is having a communications problem with an external device or pressure generation/control component.	Check setup and communications with external vacuum gauge or pressure generation/control component. PG7000 Operation and Maintenance Manual
ADCS component displays <*****> or <OVERFLOW> where a numerical value should be.	Number to be displayed is too large for allocated space. Usually due to an erroneous setting or measurement causing an out of limit high value to be calculated.	Check settings that may be causing an out of limit high measurement and adjust if necessary. Product Operation and Maintenance Manual
The system's vacuum pump(s) will not run.	Blown fuse on <b>AC2</b> or <b>AC3</b> power supply connection.	Replace fuse on <b>AC2</b> or <b>AC3</b> IEC power connector on rear of Control Cabinet. Fuse is a 250 VT 10 A.
The PG Terminal constantly displays <Searching .... >.	The PG Terminal is unable to establish communications with the PG7601 Platform.	Check that the PG Terminal to Platform cable is installed correctly. If still unable to get beyond <Searching .... >, contact a <b>DHI</b> Authorized Service Provider
The PG7601 run screen is not the normal MAIN run screen.	You are in the SYSTEM or AMBIENT run screen.	Operation is normal. Press <b>[ESCAPE]</b> on PG7000 Terminal. PG7000 Operation and Maintenance Manual
PG7601 piston drop rate is excessive.	There is a leak in the pressurized system or the device under test itself.	Correct leak.
PG7601 motorized rotation will not engage.	Motorized rotation system recovering from overload or measurement made is absolute by vacuum and reference vacuum is not under <i>Ready</i> limit.	Wait 25 seconds for system to recover. PG7601 Operation and Maintenance Manual

SYMPTOM	PROBABLE CAUSE	SOLUTION
PG7601 automated motorized rotation is not operating.	Automated motorized rotation is OFF.	Press <b>[ROTATE]</b> , <b>&lt;1mA&gt;</b> PG7000 Operation and Maintenance Manual
PG7601 automated pressure control (GEN) is not starting after setting a target and loading mass AND measurement mode is absolute by vacuum.	In absolute by vacuum measurement mode, before automated pressure generation begins, the reference vacuum must be below 20 Pa.	Wait for vacuum to reach less than 20 Pa, check and correct vacuum supply if inadequate.
Automated pressure control is not increasing or decreasing pressure as expected.	Pressure or vacuum supply on the pressure controller is not adequate.	Provide correct pressure and vacuum supplies to Control Cabinet. 6.13
PG7601 motorized rotation is unable to start piston rotation.	Piston-cylinder is dirty.	Clean piston-cylinder. 6.6
PG7601 piston rotation rate slows down too quickly; motorized rotation engages too frequently.	Piston-cylinder dirty, PG7601 Platform not level, PG7601 subjected to excessive vibration, piston position indication needs to be adjusted.	Clean piston-cylinder, level PG7601 Platform, remove sources of vibration, calibrate piston position indication. 6.6
PG7601 piston position readings seem incorrect.	Piston position reading system needs to be adjusted.	Execute piston position detection adjustment procedure. 6.7
FPG8601 pressure indication is unstable when the FPG8601 is bypassed (vented).	Piston-cylinder needs to be cleaned.	Clean piston cylinder. 6.3
ADCS Tools displays <b>&lt;FPG not responding&gt;</b> .	FPG8601 is in a condition in which it cannot be used.	View in <b>ADCS Tools FPG8601 Run Screen</b> . Check for noisy output or other abnormal conditions. 4.3.6.2
Pressure defined by ADCS-601-AF is incorrect by relatively small amounts.	A pressure head is applied incorrectly or inadvertently, the value of gravity used by the system is incorrect, the PG7601 Platform is not level, information in the piston-cylinder module and/or mass set file is incorrect.	Check and correct if necessary. 4.2.6
When using automated pressure control pressure generation stopped and the controller is beeping.	Pressure reached controller's UPPER LIMIT.	Check <b>[GEN]</b> UPPER LIMIT and adjust if necessary. PG7000 Operation and Maintenance Manual
Automated pressure generation is extremely slow or never floats the pistons.	The test volume is too large.	Reduce the test volume



## 9. APPENDIX

### 9.1 CONVERSION OF NUMERICAL VALUES

PG7000 performs all internal calculations in SI units. Numerical values input or output in other units are converted to SI immediately after entry and back to other units just before output as needed.

The tables below provide the conversion coefficients used by PG7000 to convert numerical values expressed in SI units to corresponding values expressed in other units.

#### 9.1.1 PRESSURE

**Table 25.** Pressure unit of measure conversions

TO CONVERT FROM PA TO		MULTIPLY BY
Pa	Pascal	1.0
mbar	millibar	1.0 E-02
kPa	kilo Pascal	1.0 E-03
bar	Bar	1.0 E-05
mmWa @ 4°C	millimeter of water	1.019716 E-01
mmHg @ 0°C	millimeter of mercury	7.50063 E-03
psi	pound per square inch	1.450377 E-04
psf	pound per square foot	1.007206 E-06
inWa @ 4°C	inch of water	4.014649 E-03
inWa @ 20°C	inch of water	4.021732 E-03
inWa @ 60°F	inch of water	4.018429 E-03
inHg @ 0°C	inch of mercury	2.953 E-04
kcm <sup>2</sup>	kilogram force per centimeter square	1.019716 E-05
user	User	User defined coefficient

## 9.2 GLOSSARY

<b>Absolute</b>	As in absolute pressure. Pressure expressed relative to vacuum.
<b>Absolute by vacuum, avac</b>	Absolute pressure determined by defining pressure relative to vacuum in an evacuated bell jar (PG7601).
<b>ADCS Tools</b>	ADCS-601-AF software that controls the overall system. ADCS Tools is run on a personal computer that interfaces with the components of the ADCS-601-AF system.
<b>Adder</b>	A value added to sensor readings to offset the readings (pressure adder, temperature adder, humidity adder, vacuum adder) for calibration adjustment.
<b>Ae</b>	Piston-cylinder effective area.
<b>AMH</b>	Automated mass handling system. ADCS-601-AF uses an AMH-38 on the PG7601 piston gauge.
<b>Control Cabinet</b>	Main ADCS-601-AF system component. 19 in. rack mount enclosure in which the pressure controllers, pressure monitor and Gas Supply Panel are installed.
<b>DUT (Device Under Test)</b>	The device being tested or calibrated.
<b>FS (Full Scale)</b>	The full scale value is the maximum value or the span of a measurement range. Limits and specifications are often expressed as % FS.
<b>g, gl</b>	Acceleration due to gravity (g). Acceleration due to gravity at location of use (gl).
<b>Gauge</b>	As in gauge pressure. Pressure expressed relative to atmospheric pressure.
<b>Head</b>	Fluid head, a pressure difference due to a difference in height.
<b>HSTOP, LSTOP</b>	PG7601 high stop and low stop, piston maximum end of stroke positions.
<b>Measurement Mode</b>	Mode in which ADCS-601-AF is defining pressures. These include gauge (pressure relative to atmospheric pressure) and absolute (pressure relative to vacuum).
<b>MS (Mass Set)</b>	A group of masses used on the PG7601 piston gauge. In ADCS-601-AF the mass set is a an AMH-38 mass set with a nominal total mass of 38 kg.
<b>Mass Bell</b>	The combination of parts that is loaded onto the piston to carry the masses. This includes the sleeve that is slid over the piston, the binary mass tray and the lifting shaft.
<b>Medium, pressurized</b>	The pressurized fluid.
<b>Multiplier</b>	A value by which internal sensor readings are multiplied to change their slope (pressure multiplier, temperature multiplier, humidity multiplier, vacuum multiplier) for calibration adjustment.
<b>N2</b>	Nitrogen gas.
<b>Nominal Mass</b>	The mass loaded on the piston in terms of the nominal values written on the individual masses. See also True Mass.
<b>P-C</b>	Piston-cylinder, piston-cylinder module.
<b>PRT</b>	Platinum Resistance Thermometer. The element used in the piston-cylinder mounting post to measure temperature.
<b>Ready/Not Ready</b>	Indication of when conditions are present to make in tolerance pressure definitions based on specific criteria for each condition.
<b>Reference Bench</b>	Main ADCS-601-AF system component. Wood top bench onto which the system pressure stands are installed.
<b>Reference Level</b>	Height at which pressures are defined. PG7000 defines pressures at its reference level. Fluid head corrections correct the pressure relative to the reference level.
<b>Reference Pressure, Reference Pressure Circuit</b>	The pressure against which pressures are defined by the ADCS-601-AF system. Vacuum in absolute measurement mode; atmosphere in gauge measurement mode.
<b>TEST(+)</b>	Port to which the ADCS-601-AF system sets absolute or gauge pressure.
<b>TEST(-)</b>	Port connected to the reference circuit of the ADCS-601-AF pressure standards. In gauge mode, the DUT "low side" can be connected here to assure a common atmospheric reference on the DUT and the pressure standards. Port not used in absolute mode.
<b>True Mass</b>	The actual mass loaded on the piston using the measured value of each mass. See also Nominal Mass.

## 9.3 WARRANTY STATEMENT

Except to the extent limited or otherwise provided herein, **DH Instruments, a Fluke Company (DHI)** warrants for one year from purchase, (5 years for ADCS-601-AF systems purchased under AFMETCAL Contract FY2333-04-M-0021, as labeled on the instrument rear panel) each new product sold by it or one of its authorized distributors, only against defects in workmanship and/or materials under normal service and use. Products which have been changed or altered in any manner from their original design, or which are improperly or defectively installed, serviced or used are not covered by this warranty.

**DHI** and any of its Authorized Service Providers' obligations with respect to this warranty are limited to the repair or replacement of defective products after their inspection and verification of such defects. All products to be considered for repair or replacement are to be returned to **DHI**, or its Authorized Service Provider, freight prepaid, after receiving authorization from **DHI** or its Authorized Service Provider. The buyer assumes all liability vis-à-vis third parties in respect of its acts or omissions involving use of the products. In no event shall **DHI** be liable to purchaser for any unforeseeable or indirect damage, it being expressly stated that, for the purpose of this warranty, such indirect damage includes, but is not limited to, loss of production, profits, revenue, or goodwill, even if **DHI** has been advised of the possibility thereof, and regardless of whether such products are used individually or as components in other products.

Items returned to **DHI** under warranty claim but determined to not have a defect covered under warranty or to not have a defect at all are subject to an evaluation and shipping charge as well as applicable repair and/or calibration costs.

The provisions of this warranty and limitation may not be modified in any respect except in writing signed by a duly authorized officer of **DHI**.

The above warranty and the obligations and liability of **DHI** and its authorized service providers exclude any other warranties or liabilities of any kind.



*ADCS-601-AF systems delivered under certain US government contracts have extended warranties. In this case, the warranty period is listed on a sticker on the rear panel. The extended warranty extends the standard 1 year warranty, providing for remedy of defects in materials, workmanship and manufacturing. The extended warranty is not an extended service contract. Items returned for service not covered under the warranty terms are subject to standard service charges including charges for evaluation and/or analysis when no defect is found.*

**Table 26. DHI Authorized Service Providers**

DH INSTRUMENTS, A FLUKE COMPANY AUTHORIZED SERVICE PROVIDERS			
COMPANY	ADDRESS	TELEPHONE, FAX & EMAIL	NORMAL SUPPORT REGION
DH Instruments, a Fluke Company	4765 East Beautiful Lane Phoenix AZ 85044-5318 USA	Tel 602.431.9100 Fax 602.431.9559 cal.repair@dhinstruments.com	Worldwide
Minerva Meettechniek B.V.	Chrysantstraat 1 3812 WX Amersfoort the NETHERLANDS	Tel (+31) 33.46.22.000 Fax (+31) 33.46.22.218 <a href="mailto:info@minervaipm.com">info@minervaipm.com</a>	European Union
Nippon CalService, Inc.	2-9-1 Sengen, Tsukuba-Shi Ibaraki Prefecture 305 JAPAN	Tel 0298-55-8778 Fax 0298-55-8700 tohte@ohtegiken.co.jp	Japan/Asia

## NOTES